



Air handling units

Centrales de traitement d'air simple flux

Lüftungsgeräte

Приточные агрегаты



- Low noise level.
- Adjustable voltage fan control.
- Electrical or water heater.
- Easily removable inspection cover.
- Filter box with pocket filter F5 class.
- Possibility to install under the ceiling.
- Optional wide range controls available.

Air supply units for ventilation systems. Units' casing is made of galvanized steel and have insulation of 50 mm. Consists of centrifugal fan, heater (electrical or water), pocket filter. Not designed for functioning in explosive – inclined areas. Units are designed for clean air supply into premises. Have additional mounting brackets for under the ceiling installation.



- Niedriges Geräuschniveau.
- Ventilator mit Geschwindigkeitsregelung (Spannungsänderung).
- Elektrische oder Wasser-Erwärmungseinrichtung.
- Leicht abnehmbarer Deckel für Wartung.
- Filterkasten mit dem Filter der F5-Klasse.
- 

Das Zuluft-Aggregat ist für Luftlieferung in Räumlichkeiten bestimmt. Es besteht aus einem Zentrifugalventilator, dessen Geschwindigkeit mithilfe eines Reglers gesteuert werden kann, einer Lufterwärmungseinrichtung und einem Taschenfilter. Alle diese Elemente sind im isolierten Gehäuse montiert. Isolationsdicke 50 mm. Das Gehäuse ist aus verzinktem Blech mit leicht abnehmbarem Deckel hergestellt. Der Deckel wird mit vier leicht aufknöpfbaren Scharnieren befestigt.



- Faible niveau de bruit.
- Ventilateur à vitesse réglée (changement d'intensité).
- Batterie électrique ou à eau chaude.
- Ouverture facile du panneau.
- Cassette de filtres avec filtre de classe F5.
- Large éventail de régulation disponible.

Les unités sont destinées à l'apport d'air dans les locaux. Elles se composent d'un ventilateur centrifuge dont la vitesse peut être pilotée par un régulateur, d'une batterie terminale et d'un filtre à poche. Tous ces éléments sont montés dans une enveloppe isolée. Épaisseur de l'isolation 50 mm. L'enveloppe est réalisée en tôle galvanisée avec un panneau pouvant être facilement ouvert.

Le panneau est consolidé par quatre charnières facilement détachables.



- Низкий уровень шума.
- Вентилятор с регулированием скорости (изменение напряжения).
- Электрический или водяной нагреватель.
- Легко снимаемая крышка для проверки.
- Кассета фильтров с фильтром класса F5.
- Дополнительно широкий спектр по подбору автоматики.

Агрегат подачи воздуха предназначен для подачи воздуха в помещения. Он состоит из эксцентрического вентилятора, скорость которого изменяется регулятором, а также нагревателя воздуха и карманного фильтра. Все эти элементы установлены в изолированном корпусе. Толщина изоляции 50 мм. Корпус изготовлен из оцинкованной жести с легко снимаемой крышкой. Крышка крепится легко отстегивающимися шарнирами.

## Accessories

Single phase speed controller	Three phase speed controller	Monophase speed controller	Controller for electrical heater	Controller for electrical heater	Back draft shutter	Shuft-off damper	Circular ducts silencer
							
TGRV p. 191	TGRT p. 192	MTY p. 193	EKR 15.1P EKR 15.1 p. 188	EKR 6.1 p. 190	RSK p. 195	SKG p. 194	AKS p. 198

VEKA 400 - 2000

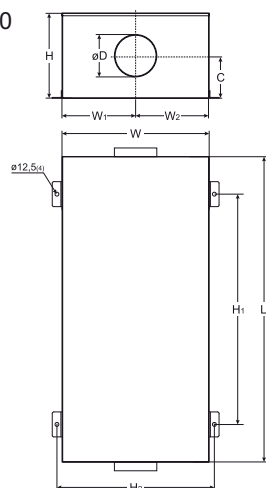



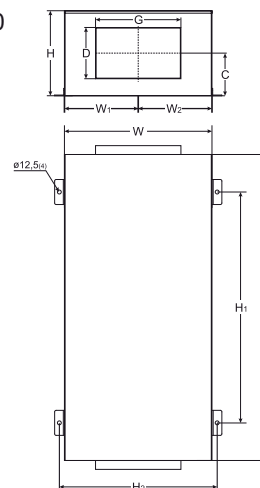





VEKA 3000 - 4000

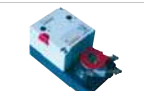

Type	Dimensions [mm]								
	W	W <sub>1</sub>	W <sub>2</sub>	C	L	H	ØD	H <sub>1</sub>	H <sub>2</sub>
VEKA 400	434	215	215	125	880	250	125	920	350
VEKA 700/2,4 - 12,0	459	228	228	207	955	400	160	996	375
VEKA 850/2,0 - 3,0	464	230	230	216	1000	400	200	700	500
VEKA 850/5,0 - 9,0	464	230	230	216	1100	400	200	800	500
VEKA 850/12,0	464	230	230	216	1230	400	200	880	500
VEKA 1000/2,4	614	210	400	198	1150	400	250	850	650
VEKA 1000/5,0	614	210	400	198	1300	400	250	900	650
VEKA 1000/9,0 - 12,0	614	210	400	198	1400	400	250	900	650
VEKA W-1000/13,6	614	210	400	198	1400	400	250	950	650
VEKA 2000	704	285	415	256	1500	500	315	1000	740

Type	Dimensions [mm]									
	W	W <sub>1</sub>	W <sub>2</sub>	C	L	H	D	G	H <sub>1</sub>	H <sub>2</sub>
VEKA 3000	824	410	410	239	1500	500	300	500	1000	860
VEKA 4000	924	460	460	300	1700	600	400	600	1400	960

## Accessories

Damper for rectangular ducts	Rectangular ducts silencer	Actuator for damper	Differential pressure switch	Duct sensor	Thermic water valve actuator	Mixing point	2 and 3 way valves
							
SSK p. 196	SSP p. 200	SP p. 163	PS p. 161	TJK 10K p. 162	SSB p. 158	RMG p. 159	VVP/VXP p. 160

Type	Accessories													
	TGRV	TGRT	MTY	EKR 15.1 EKR 15.1P	EKR 6.1	RSK SKG AKS AP	SSK SSP	SP PS	TJK 10K	SSB <i>Heating</i>	RMG 80/60°C	RMG 60/40°C	VVP/VXP 80/60°C	VVP/VXP 60/40°C
VEKA 400/1,2-L1	1	-	1,5	-	+	125	-	+	+	-	-	-	-	-
VEKA 400/2,0-L1	1	-	1,5	-	+	125	-	+	+	-	-	-	-	-
VEKA 400/5,0-L1	1	-	1,5	-	+	125	-	+	+	-	-	-	-	-
VEKA 700/2,4-L1	1,5	-	1,5	-	+	160	-	+	+	-	-	-	-	-
VEKA 700/5,0-L1	1,5	-	1,5	-	+	160	-	+	+	-	-	-	-	-
VEKA 700/9,0-L1	1,5	-	1,5	15.1	-	160	-	+	+	-	-	-	-	-
VEKA 700/12,0-L1	1,5	-	1,5	15.1	-	160	-	+	+	-	-	-	-	-
VEKA 850/2,0-L1	2	-	1,5	-	+	200	-	+	+	-	-	-	-	-
VEKA 850/3,0-L1	2	-	1,5	-	+	200	-	+	+	-	-	-	-	-
VEKA 850/5,0-L1	2	-	1,5	-	+	200	-	+	+	-	-	-	-	-
VEKA 850/6,0-L1	2	-	1,5	-	+	200	-	+	+	-	-	-	-	-
VEKA 850/9,0-L1	2	-	1,5	15.1	-	200	-	+	+	-	-	-	-	-
VEKA 850/12,0-L1	2	-	1,5	15.1	-	200	-	+	+	-	-	-	-	-
VEKA1000/2,4-L1	5	-	4	-	+	250	-	+	+	-	-	-	-	-
VEKA1000/2,4-L3	-	3	-	-	+	250	-	+	+	-	-	-	-	-
VEKA1000/5,0-L1	5	-	4	-	+	250	-	+	+	-	-	-	-	-
VEKA1000/5,0-L3	-	3	-	-	+	250	-	+	+	-	-	-	-	-
VEKA1000/9,0-L1	5	-	4	15.1	-	250	-	+	+	-	-	-	-	-
VEKA1000/9,0-L3	-	3	-	15.1	-	250	-	+	+	-	-	-	-	-
VEKA1000/12,0-L1	5	-	4	15.1	-	250	-	+	+	-	-	-	-	-
VEKA1000/12,0-L3	-	3	-	15.1	-	250	-	+	+	-	-	-	-	-
VEKA W-1000/13,6-L1	5	-	4	-	-	250	-	+	-	81*	3-1,6-4	3-1,0-4	45.10-1,6	45.10-1,0
VEKA W-1000/13,6-L3	-	3	-	-	-	250	-	+	-	81*	3-1,6-4	3-1,0-4	45.10-1,6	45.10-1,0
VEKA 2000/6,0-L1	11	-	-	-	+	315	-	+	+	-	-	-	-	-
VEKA 2000/6,0-L3	-	4	-	-	+	315	-	+	+	-	-	-	-	-
VEKA 2000/15,0-L1	11	-	-	15.1	-	315	-	+	+	-	-	-	-	-
VEKA 2000/15,0-L3	-	4	-	15.1	-	315	-	+	+	-	-	-	-	-
VEKA 2000/21,0-L1	11	-	-	15.1P	-	315	-	+	+	-	-	-	-	-
VEKA 2000/21,0-L3	-	4	-	15.1P	-	315	-	+	+	-	-	-	-	-
VEKA W-2000/27,2-L1	11	-	-	-	-	315	-	+	-	81*	3-2,5-4	3-1,6-4	45.15-2,5	45.10-1,6
VEKA W-2000/27,2-L3	-	4	-	-	-	315	-	+	-	81*	3-2,5-4	3-1,6-4	45.15-2,5	45.10-1,6
VEKA 3000/15,0-L1	14	-	-	15.1	-	-	500x300	+	+	-	-	-	-	-
VEKA 3000/15,0-L3	-	7	-	15.1	-	-	500x300	+	+	-	-	-	-	-
VEKA 3000/21,0-L1	14	-	-	15.1P	-	-	500x300	+	+	-	-	-	-	-
VEKA 3000/21,0-L3	-	7	-	15.1P	-	-	500x300	+	+	-	-	-	-	-
VEKA 3000/30,0-L1	14	-	-	15.1P	-	-	500x300	+	+	-	-	-	-	-
VEKA 3000/30,0-L3	-	7	-	15.1P	-	-	500x300	+	+	-	-	-	-	-
VEKA 3000/39,0-L1	14	-	-	15.1P	-	-	500x300	+	+	-	-	-	-	-
VEKA 3000/39,0-L3	-	7	-	15.1P	-	-	500x300	+	+	-	-	-	-	-
VEKA W-3000/40,8-L1	14	-	-	15.1P	-	-	500x300	+	-	81*	3-4,0-4	3-2,5-4	45.20-4,0	45.15-2,5
VEKA W-3000/40,8-L3	-	7	-	15.1P	-	-	500x300	+	-	81*	3-4,0-4	3-2,5-4	45.20-4,0	45.15-2,5
VEKA 4000/21,0-L3	-	11	-	15.1P	-	-	600x400	+	+	-	-	-	-	-
VEKA 4000/27,0-L3	-	11	-	15.1P	-	-	600x400	+	+	-	-	-	-	-
VEKA 4000/39,0-L3	-	11	-	15.1P	-	-	600x400	+	+	-	-	-	-	-
VEKA4000/54,0-L3	-	11	-	15.1P	-	-	600x400	+	+	-	-	-	-	-
VEKA W-4000/54,0-L3	-	11	-	-	-	-	600x400	+	+	81*	3-6,3-4	3-4,0-4	45.25-6,3	45.20-4,0

\* - only with PRV control board

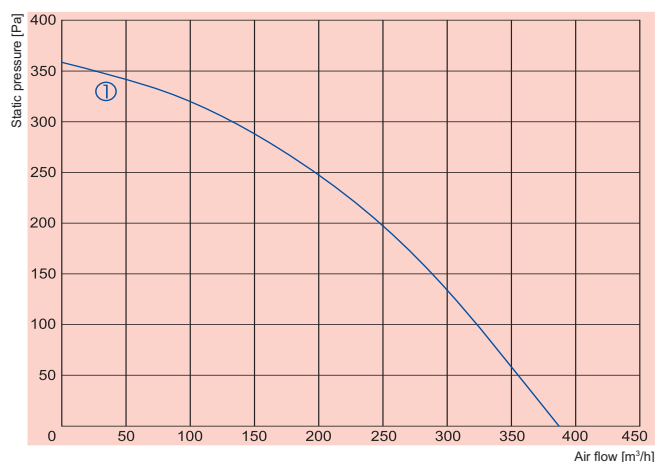

- ① VEKA 400/1,2-L1
- ① VEKA 400/2,0-L1
- ① VEKA 400/5,0-L1

		400/1,2-L1	400/2,0-L1	400/5,0-L1
Heater	-phase/voltage [50Hz/VAC]	~1, 230	~1, 230	~2, 400
	-power consumption [kW]	1,2	2,0	5,0
	-min. air speed [m/s]	1,5	1,5	1,5
Fan	-phase/voltage [50Hz/VAC]	~1, 230	~1, 230	~1, 230
	-current [A]	0,64	0,64	0,64
	-speed [min <sup>-1</sup> ]	2300	2300	2300
	-power consumption [kW]	0,147	0,147	0,147
	-max. airflow [m³/h]	414	414	414
-motor protection class		IP-44	IP-44	IP-44
Terminal box protection class		IP-54	IP-54	IP-54
Filter class		F5	F5	F5
Total sound pressure level at 1 m [dBA]		41	41	41
Wiring diagram		No. 1	No. 1	No. 2

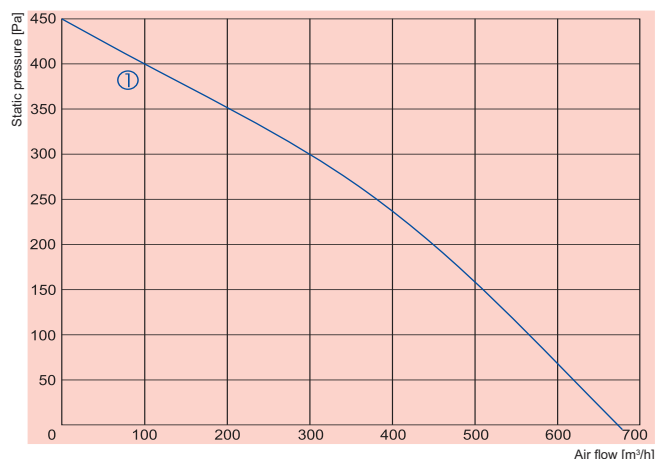

- ① VEKA 700/2,4-L1
- ① VEKA 700/5,0-L1
- ① VEKA 700/9,0-L1
- ① VEKA 700/12,0-L1

		700/2,4-L1	700/5,0-L1	700/9,0-L1	700/12,0-L1
Heater	-phase/voltage [50Hz/VAC]	~1, 230	~2, 400	~3, 400	~3, 400
	-power consumption [kW]	2,4	5,0	9,0	12,0
	-min. air speed [m/s]	1,5	1,5	1,5	1,5
Fan	-phase/voltage [50Hz/VAC]	~1, 230	~1, 230	~1, 230	~1, 230
	-current [A]	0,93	0,93	0,93	0,93
	-speed [min <sup>-1</sup> ]	2200	2200	2200	2200
	-power consumption [kW]	0,214	0,214	0,214	0,214
	-max. airflow [m³/h]	680	680	680	680
-motor protection class		IP-44	IP-44	IP-44	IP-44
Terminal box protection class		IP-54	IP-54	IP-54	IP-54
Filter class		F5	F5	F5	F5
Total sound pressure level at 1 m [dBA]		45	45	45	45
Wiring diagram		No. 1	No. 2	No. 3	No. 3

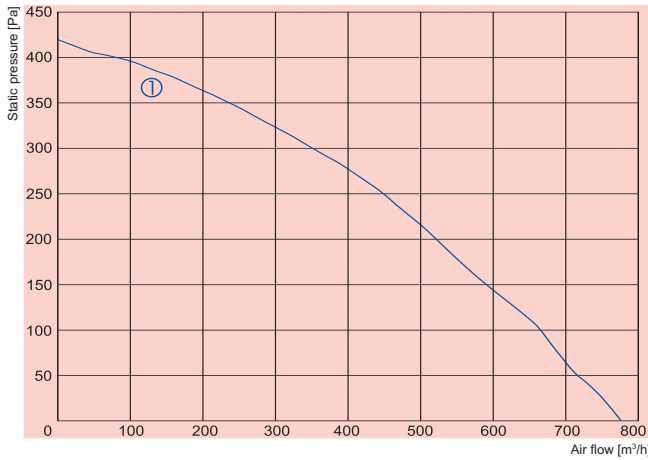

- ① VEKA 850/2,0-L1
- ① VEKA 850/3,0-L1
- ① VEKA 850/5,0-L1
- ① VEKA 850/6,0-L1
- ① VEKA 850/9,0-L1
- ① VEKA 850/12,0-L1

		850/2,0-L1	850/3,0-L1	850/5,0-L1	850/6,0-L1	850/9,0-L1	850/12,0-L1
Heater	-phase/voltage [50Hz/VAC]	~1, 230	~1, 230	~2, 400	~2, 400	~3, 400	~3, 400
	-power consumption [kW]	2	3	5	6	9	12
	-min. air speed [m/s]	1,5	1,5	1,5	1,5	1,5	1,5
Fan	-phase/voltage [50Hz/VAC]	~1, 230	~1, 230	~1, 230	~1, 230	~1, 230	~1, 230
	-current [A]	0,98	0,98	0,98	0,98	0,98	0,98
	-speed [min <sup>-1</sup> ]	2000	2000	2000	2000	2000	2000
	-power consumption [kW]	0,25	0,25	0,25	0,25	0,25	0,25
	-max. airflow [m³/h]	805	805	805	805	805	805
	-motor protection class	IP-44	IP-44	IP-44	IP-44	IP-44	IP-44
Terminal box protection class		IP-54	IP-54	IP-54	IP-54	IP-54	IP-54
Filter class		F5	F5	F5	F5	F5	F5
Total sound pressure level at 1 m [dBA]		46	46	46	46	46	46
Wiring diagram		No. 1	No. 1	No. 2	No. 2	No. 3	No. 3

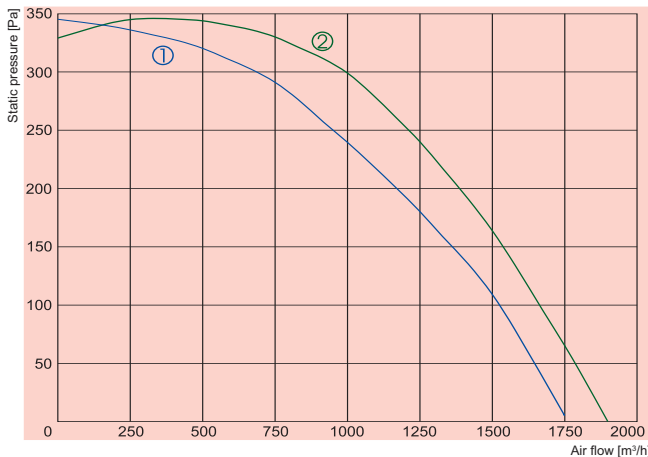

- ① VEKA1000/2,4-L1
- ② VEKA1000/2,4-L3
- ① VEKA1000/5,0-L1
- ② VEKA1000/5,0-L3

		1000/2,4-L1	1000/2,4-L3	1000/5,0-L1	1000/5,0-L3
Heater	-phase/voltage [50Hz/VAC]	~1, 230	~1, 230	~2, 400	~2, 400
	-power consumption [kW]	2,4	2,4	5	5
	-min. air speed [m/s]	1,5	1,5	1,5	1,5
Fan	-phase/voltage [50Hz/VAC]	~1, 230	~3, 400	~1, 230	~3, 400
	-current [A]	3,0	1,9	3,0	1,9
	-speed [min <sup>-1</sup> ]	1190	1380	1190	1380
	-power consumption [kW]	0,69	0,93	0,69	0,93
	-max. airflow [m³/h]	1750	1900	1750	1900
	-motor protection class	IP-54	IP-54	IP-54	IP-54
Terminal box protection class		IP-54	IP-54	IP-54	IP-54
Filter class		F5	F5	F5	F5
Total sound pressure level at 1 m [dBA]		52	52	52	52
Wiring diagram		No. 4	No. 5	No. 6	No. 7

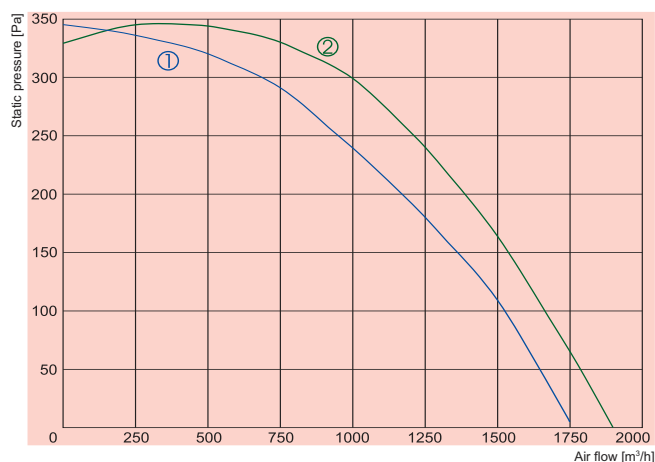

- ① — VEKA1000/9,0-L1
- ② — VEKA1000/9,0-L3
- ① — VEKA1000/12,0-L1
- ② — VEKA1000/12,0-L3

		1000/9,0-L1	1000/9,0-L3	1000/12,0-L1	1000/12,0-L3
Heater	-phase/voltage [50Hz/VAC]	~3,400	~3,400	~3,400	~3,400
	-power consumption [kW]	9	9	12	12
	-min. air speed [m/s]	1,5	1,5	1,5	1,5
Fan	-phase/voltage [50Hz/VAC]	~1,230	~3,400	~1,230	~3,400
	-current [A]	3,0	1,9	3,0	1,9
	-speed [min <sup>-1</sup> ]	1190	1380	1190	1380
	-power consumption [kW]	0,69	0,93	0,69	0,93
	-max. airflow [m³/h]	1750	1900	1750	1900
-motor protection class		IP-54	IP-54	IP-54	IP-54
Terminal box protection class		IP-54	IP-54	IP-54	IP-54
Filter class		F5	F5	F5	F5
Total sound pressure level at 1 m [dBA]		52	52	52	52
Wiring diagram		No. 8	No. 9	No. 12	No. 13

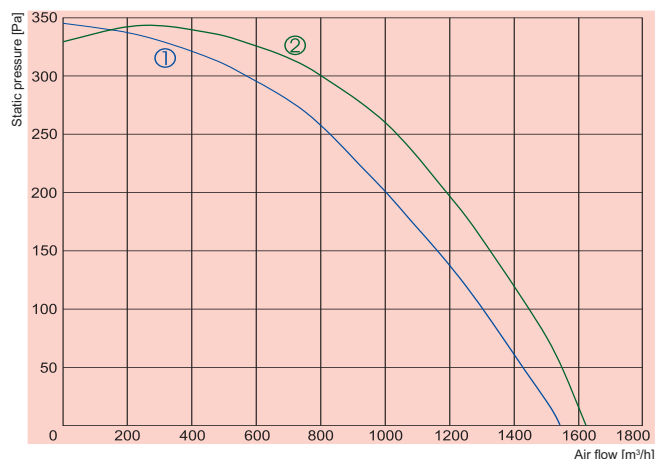

- ① — VEKA W-1000/13,6-L1
- ② — VEKA W-1000/13,6-L3

		W-1000/13,6-L1	W-1000/13,6-L3
Water heater	-power [kW]	13,6	13,6
	-water temp. T <sub>in</sub> /T <sub>out</sub> [°C]	+80/+60	+80/+60
	-water flow rate [l/s]	0,17	0,17
	-water pressure drop [kPa]	13,81	13,81
	-kvs value [m³/h]	1,5	1,5
Fan	-phase/voltage [50Hz/VAC]	~1,230	~3,400
	-current [A]	3,0	1,9
	-speed [min <sup>-1</sup> ]	1190	1380
	-power consumption [kW]	0,69	0,93
	-max. airflow [m³/h]	1540	1620
-motor protection class		IP-54	IP-54
Terminal box protection class		IP-54	IP-54
Filter class		F5	F5
Total sound pressure level at 1 m [dBA]		52	52
Wiring diagram		No. 14	No. 15

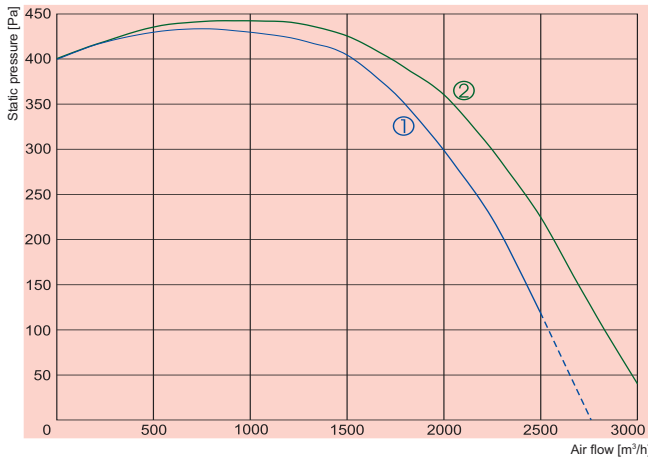

- ① VEKA 2000/6,0-L1
- ② VEKA 2000/6,0-L3
- ① VEKA 2000/15,0-L1
- ② VEKA 2000/15,0-L3
- ① VEKA 2000/21,0-L1
- ② VEKA 2000/21,0-L3

		2000/6,0-L1	2000/6,0-L3	2000/15,0-L1	2000/15,0-L3	2000/21,0-L1	2000/21,0-L3
Heater	-phase/voltage [50Hz/VAC]	~2, 400	~2, 400	~3, 400	~3, 400	~3, 400	~3, 400
	-power consumption [kW]	6	6	15	15	21 (9+12)	21 (9+12)
	-min. air speed [m/s]	1,5	1,5	1,5	1,5	1,5	1,5
Fan	-phase/voltage [50Hz/VAC]	~1, 230	~3, 400	~1, 230	~3, 400	~1, 230	~3, 400
	-current [A]	5,1	2,6	5,1	2,6	5,1	2,6
	-speed [min <sup>-1</sup> ]	1210	1310	1210	1310	1210	1310
	-power consumption [kW]	1,15	1,50	1,15	1,50	1,15	1,50
	-max. airflow [m³/h]	2500	3000	2500	3000	2500	3000
	-motor protection class	IP-54	IP-54	IP-54	IP-54	IP-54	IP-54
Terminal box protection class		IP-54	IP-54	IP-54	IP-54	IP-54	IP-54
Filter class		F5	F5	F5	F5	F5	F5
Total sound pressure level at 1 m [dBA]		54	54	54	54	54	54
Wiring diagram		No. 10	No. 11	No. 12	No. 13	No. 12	No. 13

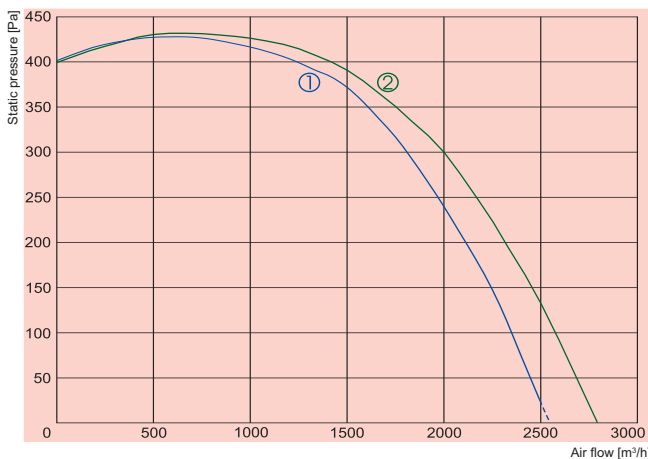

- ① VEKA W-2000/27,2-L1
- ② VEKA W-2000/27,2-L3

		W-2000/27,2-L1	W-2000/27,2-L3
Water heater	-power [kW]	27,2	27,2
	-water temp. T <sub>in</sub> /T <sub>out</sub> [°C]	+80/+60	+80/+60
	-water flow rate [l/s]	0,32	0,32
	-water pressure drop [kPa]	9,6	9,6
-kvs value [m³/h]		3,7	3,7
Fan	-phase/voltage [50Hz/VAC]	~1, 230	~3, 400
	-current [A]	5,1	2,6
	-speed [min <sup>-1</sup> ]	1210	1310
	-power consumption [kW]	1,15	1,50
	-max. airflow [m³/h]	2500	2790
	-motor protection class	IP-54	IP-54
Terminal box protection class		IP-54	IP-54
Filter class		F5	F5
Total sound pressure level at 1 m [dBA]		54	54
Wiring diagram		No. 14	No. 15

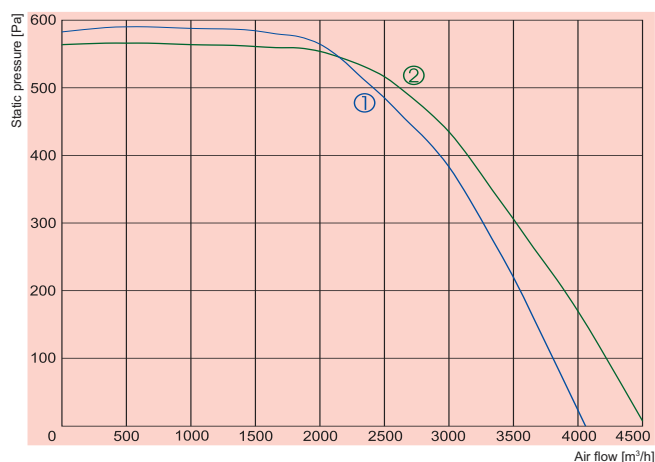

- ① VEKA 3000/15,0-L1
- ② VEKA 3000/15,0-L3
- ① VEKA 3000/21,0-L1
- ② VEKA 3000/21,0-L3

		3000/15,0-L1	3000/15,0-L3	3000/21,0-L1	3000/21,0-L3
Heater	-phase/voltage [50Hz/VAC]	~3, 400	~3, 400	~3, 400	~3, 400
	-power consumption [kW]	15	15	21 (9+12)	21 (9+12)
	-min. air speed [m/s]	1,5	1,5	1,5	1,5
Fan	-phase/voltage [50Hz/VAC]	~1, 230	~3, 400	~1, 230	~3, 400
	-current [A]	11,0	4,1	11,0	4,1
	-speed [min <sup>-1</sup> ]	1340	1300	1340	1300
	-power consumption [kW]	2,5	2,5	2,5	2,5
	-max. airflow [m³/h]	4000	4500	4000	4500
-motor protection class		IP 54	IP 54	IP 54	IP 54
Terminal box protection class		IP 54	IP 54	IP 54	IP 54
Filter class		F5	F5	F5	F5
Total sound pressure level at 1 m [dBA]		56	56	56	56
Wiring diagram		No. 12	No. 13	No. 12	No. 13

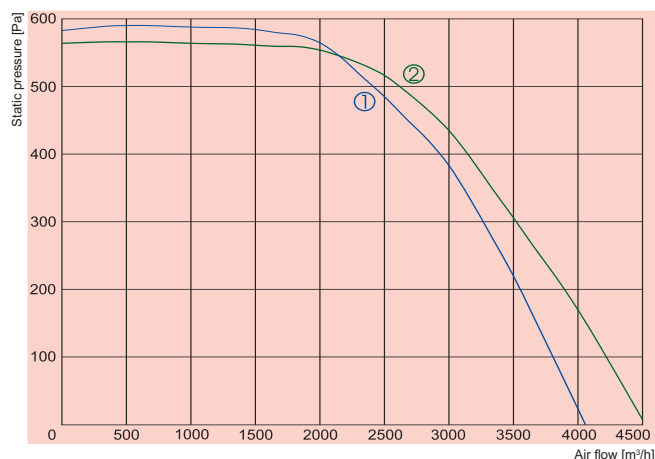

- ① VEKA 3000/30,0-L1
- ② VEKA 3000/30,0-L3
- ① VEKA 3000/39,0-L1
- ② VEKA 3000/39,0-L3

		3000/30,0-L1	3000/30,0-L3	3000/39,0-L1	3000/39,0-L3
Heater	-phase/voltage [50Hz/VAC]	~3, 400	~3, 400	~3, 400	~3, 400
	-power consumption [kW]	30 (15+15)	30 (15+15)	39 (9+12+18)	39 (9+12+18)
	-min. air speed [m/s]	1,5	1,5	1,5	1,5
Fan	-phase/voltage [50Hz/VAC]	~1, 230	~3, 400	~1, 230	~3, 400
	-current [A]	11,0	4,1	11,0	4,1
	-speed [min <sup>-1</sup> ]	1340	1300	1340	1300
	-power consumption [kW]	2,5	2,5	2,5	2,5
	-max. airflow [m³/h]	4000	4500	4000	4500
-motor protection class		IP 54	IP 54	IP 54	IP 54
Terminal box protection class		IP 54	IP 54	IP 54	IP 54
Filter class		F5	F5	F5	F5
Total sound pressure level at 1 m [dBA]		56	56	56	56
Wiring diagram		No. 12	No. 13	No. 12	No. 13

**SALDA**

AIR HANDLING UNITS



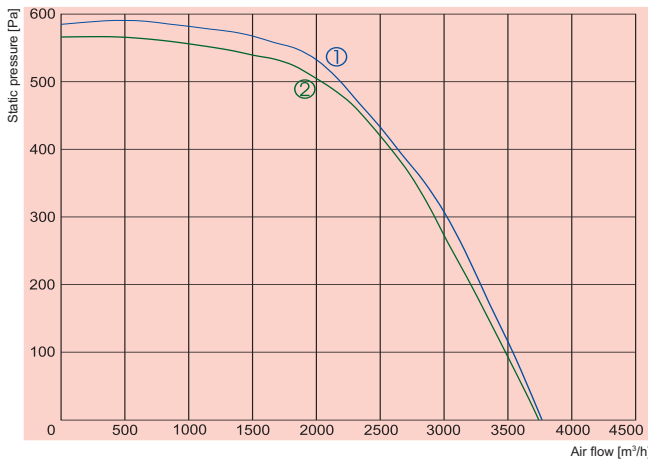

- ① VEKA W-3000/40,8-L1
- ② VEKA W-3000/40,8-L3

		W-3000/40,8-L1	W-3000/40,8-L3
Water heater	-power [kW]	40,8	40,8
	-water temp. $T_{in}/T_{out}$ [°C]	+80/+60	+80/+60
	-water flow rate [l/s]	0,49	0,49
	-water pressure drop [kPa]	5,7	5,7
	-kvs value [m³/h]	7,4	7,4
Fan	-phase/voltage [50Hz/VAC]	~1, 230	~3, 400
	-current [A]	11	4,10
	-speed [min <sup>-1</sup> ]	1340	1300
	-power consumption [kW]	2,5	2,5
	-max. airflow [m³/h]	3770	3740
	-motor protection class	IP 54	IP 54
Terminal box protection class		IP 54	IP 54
Filter class		F5	F5
Total sound pressure level at 1 m	[dBA]	56	56
Wiring diagram		No. 14	No. 15

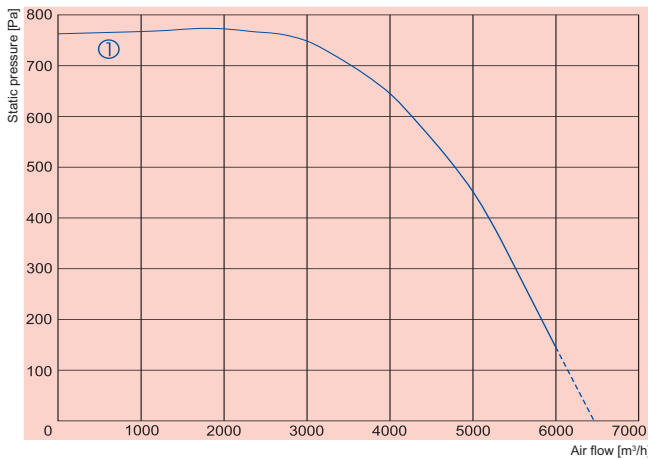

- ① VEKA 4000/21,0-L3
- ① VEKA 4000/27,0-L3
- ① VEKA 4000/39,0-L3
- ① VEKA 4000/54,0-L3

		4000/21,0-L3	4000/27,0-L3	4000/39,0-L3	4000/54,0-L3
Heater	-phase/voltage [50Hz/VAC]	~3, 400	~3, 400	~3, 400	~3, 400
	-power consumption [kW]	21 (9+12)	27 (12+15)	39 (9+12+18)	54 (9+12+15+18)
	-min. air speed [m/s]	1,5	1,5	1,5	1,5
Fan	-phase/voltage [50Hz/VAC]	~3, 400	~3, 400	~3, 400	~3, 400
	-current [A]	6,0	6,0	6,0	6,0
	-speed [min <sup>-1</sup> ]	1320	1320	1320	1320
	-power consumption [kW]	3,7	3,7	3,7	3,7
	-max. airflow [m³/h]	6020	6020	6020	6020
	-motor protection class	IP 54	IP 54	IP 54	IP 54
Terminal box protection class		IP 54	IP 54	IP 54	IP 54
Filter class		F5	F5	F5	F5
Total sound pressure level at 1 m	[dBA]	58	58	58	58
Wiring diagram		No. 13	No. 13	No. 13	No. 13



## VEKA 400E; 700E; 850E; 1000E versions with electrical heater (view from inspection side)

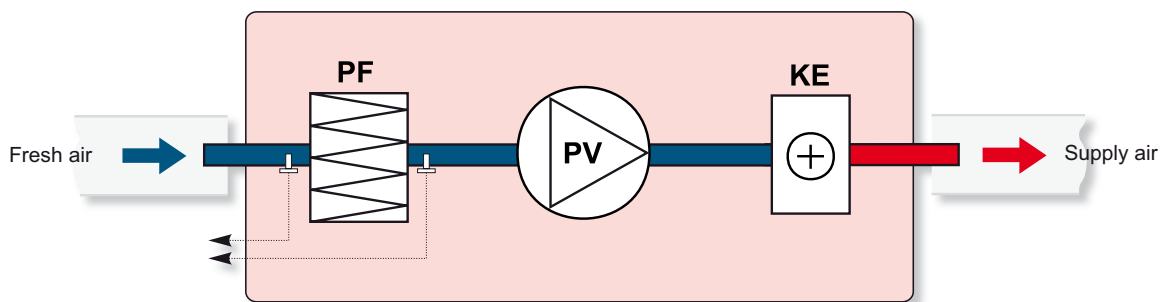

- PV - supply air fan
- PF - filter for supply air (class F5)
- KE - electrical heater

## VEKA 2000E; 3000E; 4000E versions with electrical heater (view from inspection side)

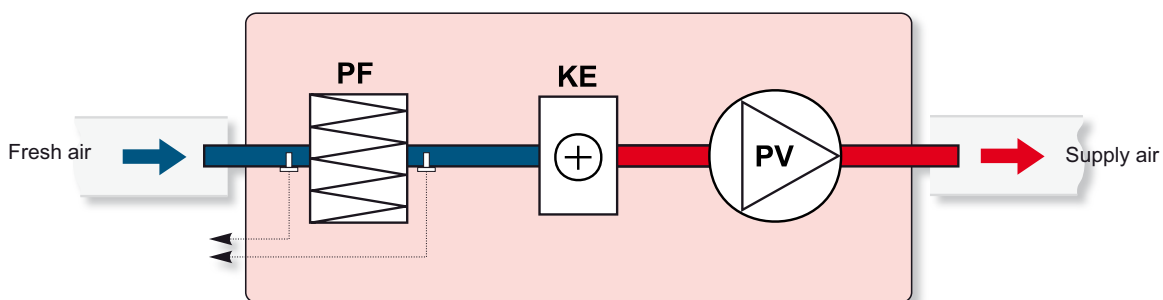

- PV - supply air fan
- PF - filter for supply air (class F5)
- KE - electrical heater

**VEKA 1000W versions with water heater (view from inspection side)**

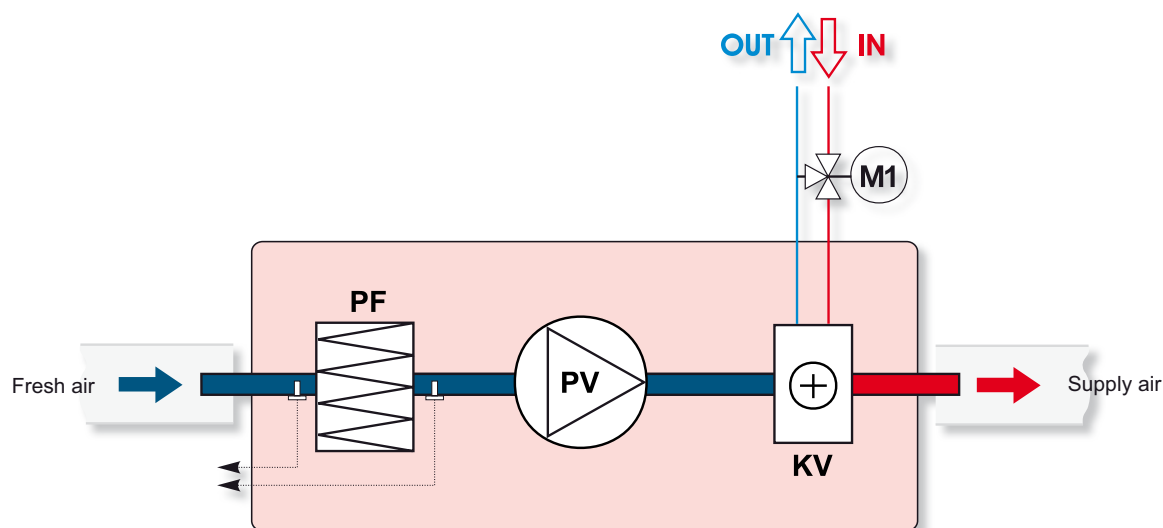

- PV - supply air fan
- PF - filter for supply air (class F5)
- KV - water heater
- M1 - optionally supplied mixing valve and motor

**VEKA 2000W; 3000W; 4000W versions with water heater (view from inspection side)**

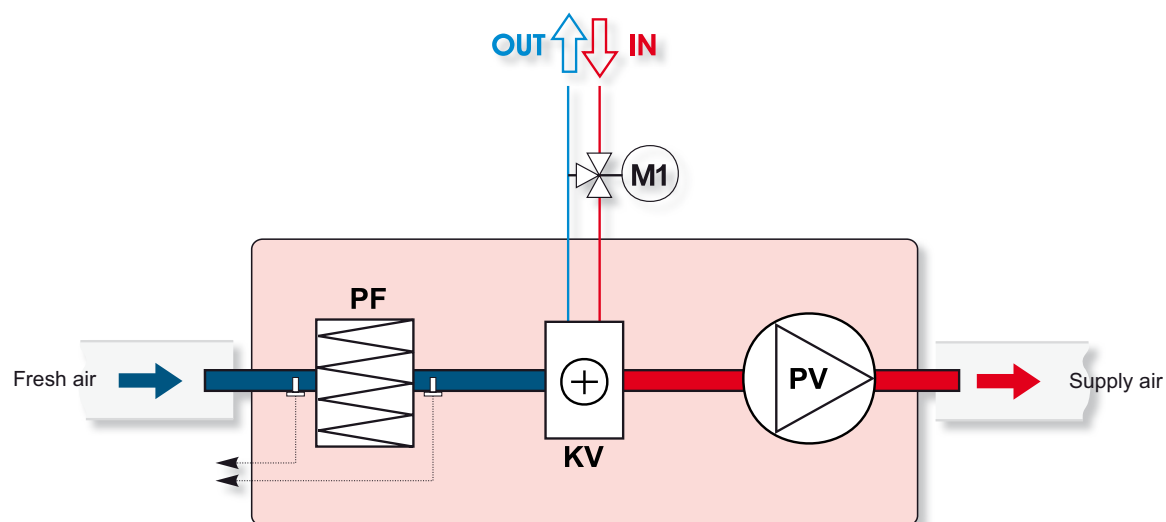

- PV - supply air fan
- PF - filter for supply air (class F5)
- KV - water heater
- M1 - optionally supplied mixing valve and motor

**SALDA**

AIR HANDLING UNITS

### Wiring diagram No. 1

C -Centrifugal fan  
D -Electrical heater

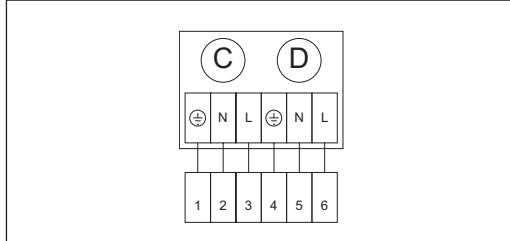

### Wiring diagram No. 2

C -Centrifugal fan  
D -Electrical heater

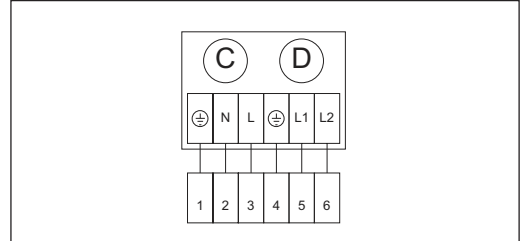

### Wiring diagram No. 3

C -Centrifugal fan  
D -Electrical heater

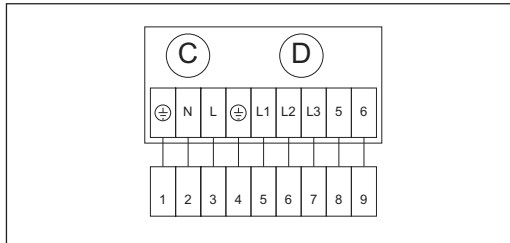

### Wiring diagram No. 4

C -Centrifugal fan  
D -Electrical heater

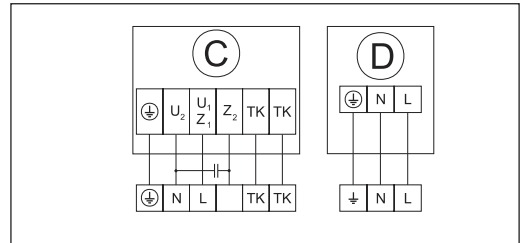

### Wiring diagram No. 5

C -Centrifugal fan  
D -Electrical heater

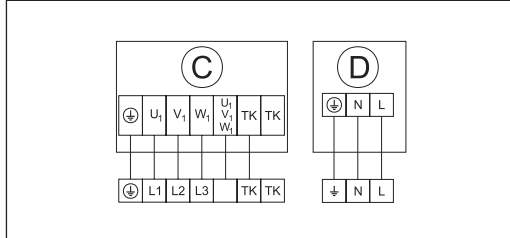

### Wiring diagram No. 6

C -Centrifugal fan  
D -Electrical heater

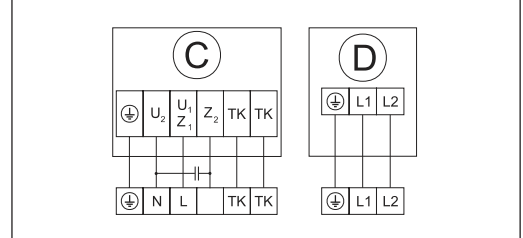

### Wiring diagram No. 7

C -Centrifugal fan  
D -Electrical heater

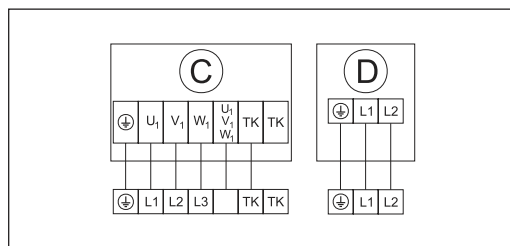

### Wiring diagram No. 8

C -Centrifugal fan  
D -Electrical heater

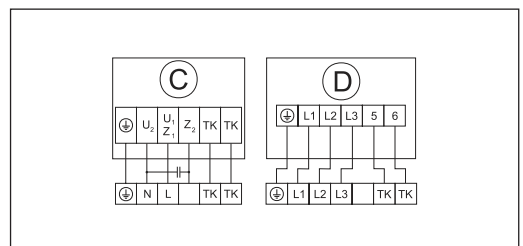

### Wiring diagram No. 9

C -Centrifugal fan  
D -Electrical heater

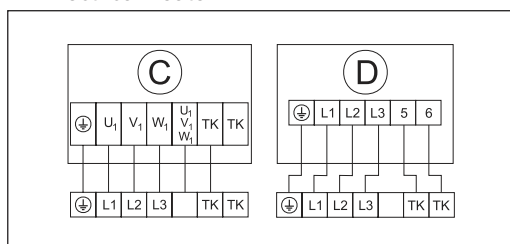

### Wiring diagram No. 10

A -Overheat protection with manual reset 100°C  
B -Overheat protection with automatical reset 50°C  
C -Centrifugal fan  
D -Electrical heater

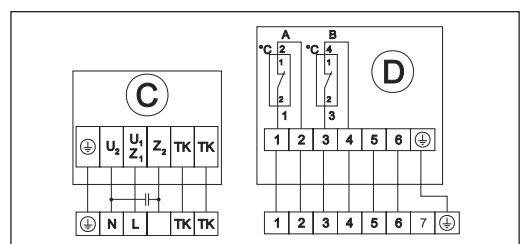

**Wiring diagram No. 11**

- A -Overheat protection with manual reset 100°C
- B -Overheat protection with automatical reset 50°C
- C -Centrifugal fan
- D -Electrical heater

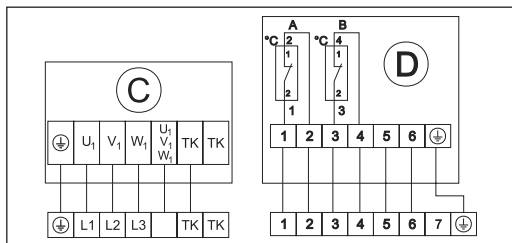

**Wiring diagram No. 12**

- A -Overheat protection with manual reset 100°C
- B -Overheat protection with automatical reset 50°C
- C -Centrifugal fan
- D -Electrical heater

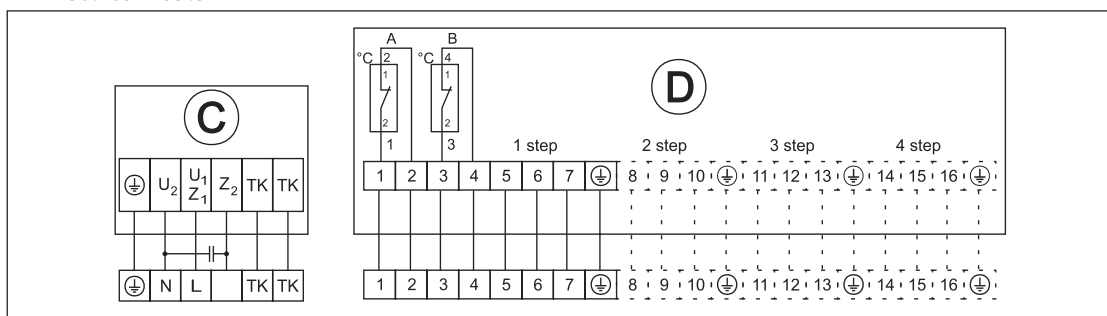

**Wiring diagram No. 13**

- A -Overheat protection with manual reset 100°C
- B -Overheat protection with automatical reset 50°C
- C -Centrifugal fan
- D -Electrical heater

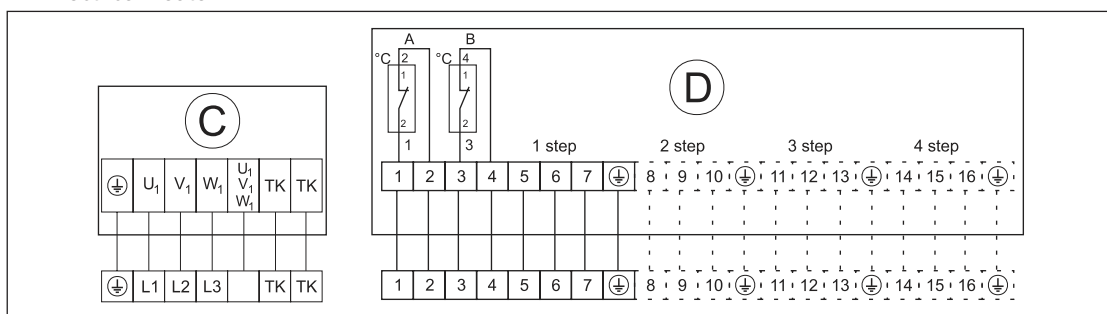

**Wiring diagram No. 14**

- C -Centrifugal fan

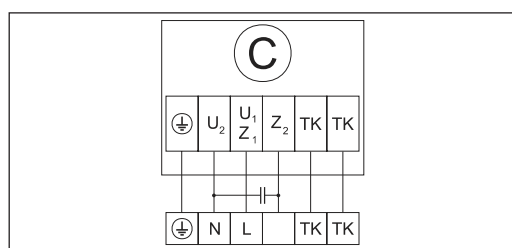

**Wiring diagram No. 15**

- C -Centrifugal fan

