

SMARTY X

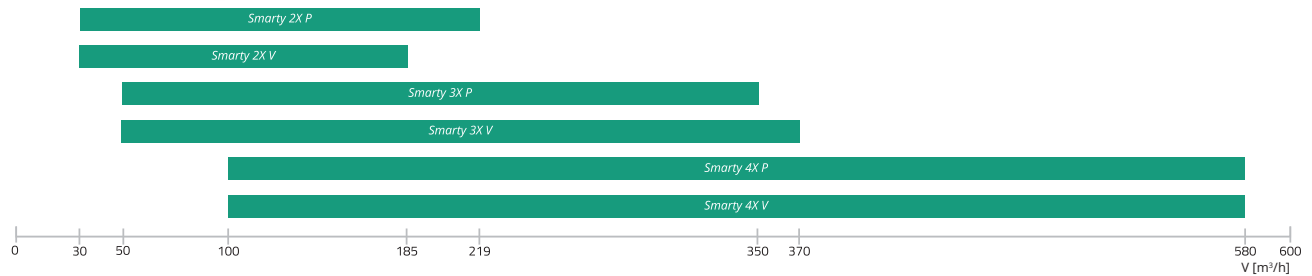

Application Apartments, private houses, villas, passive houses.

Description Residential air handling units Smarty X with EPP casing are characteristic of the highest energy efficiency (heat recovery rate – up to 94%) and user-friendly control. Universal positioning of Smarty XP units and the lowest height enable to find a place for them even in tight spaces. Due to compact sizing Smarty 2XV ideally fits in a place of a kitchen cabinet, meanwhile Smarty 3XV/4XV could fit above a regular washing machine. Every Smarty unit is tested for airtightness in order to assure exceptional quality of assembly. All internal components (fans, actuators, heat exchanger) are produced by top European manufacturers, which guarantees a long service life.

Smart control board enables controlling all components of the ventilation system.

The main features:

- › Class A+/A efficiency*;
 - › EC fans with high-efficiency counter-flow heat exchangers;
 - › High quality: Class A1 airtightness;
 - › Smart and user-friendly handling by using SALDA AIR mobile app (via optional MB-Gateway);
 - › Certified by Passivhaus Institute (Smarty 2X and 3X).
- *- depends on the unit.

Top class casing:

- › Thermal and acoustic insulation: EPP of 20-30 mm;
- › Galvanized steel plate;
- › The external side is powder-coated – corrosion class **C3**.

Heat exchanger:

- › Plastic plate heat exchanger;
- › Efficiency up to **91%** (EU 1253/2014) / **85%** (Passivhaus).

Fans:

- › EC type;
- › Specific fan input (SFI) from 0.26 W/(m³/h);
- › Long lifetime – fans last for more than 10 years.

Motorized bypass damper:

- › 100% summer bypass (night cooling);

Construction

Integrated pre-heater (Smarty 2XV/3XV/4XV version 1.1 only).

Filters:

- › Low pressure drop Coarse 65%/Coarse 65% (G4/G4) filters (effective filtration of dust, pollens);
- › Optional supply of ePM1 70% (F7) filter for more efficient filtration (moulds, spores, microscopic allergens, fine particles, bacteria).

Integrated control board²:

- › Control of external components: pre-heater, heater, dampers, etc.;
- › Connection for demand control sensors (CO2, RH, presence);
- › Intelligent frost protection;
- › Smart el.heater control 0-10V;
- › Extensive control options: 3 manual modes, boost, calendar, night cooling, fireplace mode and etc.

¹ ~40000 working hours

² Functionality depends on the unit

Air temperature sensors Extract, Supply, Outdoor.

Control options

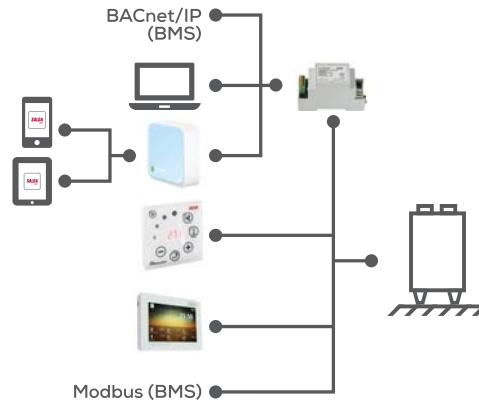

CONSTRUCTION

Smarty 2X P - 4X P

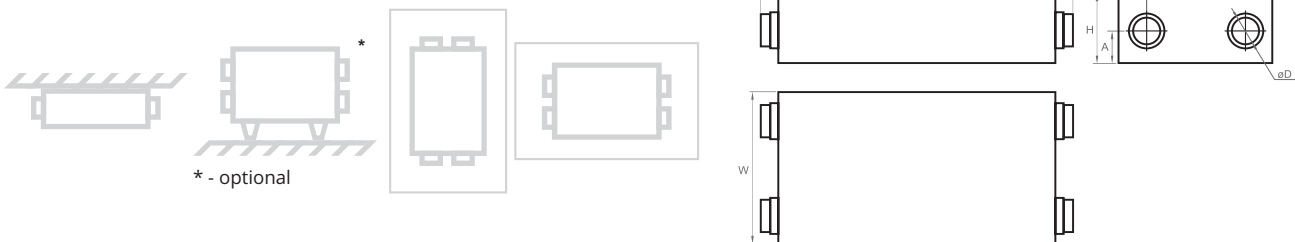

Unit	Dimensions [mm]						
	L	L1	W	H	A	B	øD
Smarty 2X P	1009	1085	590	250	113	115	125/160
Smarty 3X P	1225	1381	685	324	150	128	150/160
Smarty 4X P	1225	1381	685	324	150	128	150/160

Smarty 2X V

Smarty 3X V - 4X V

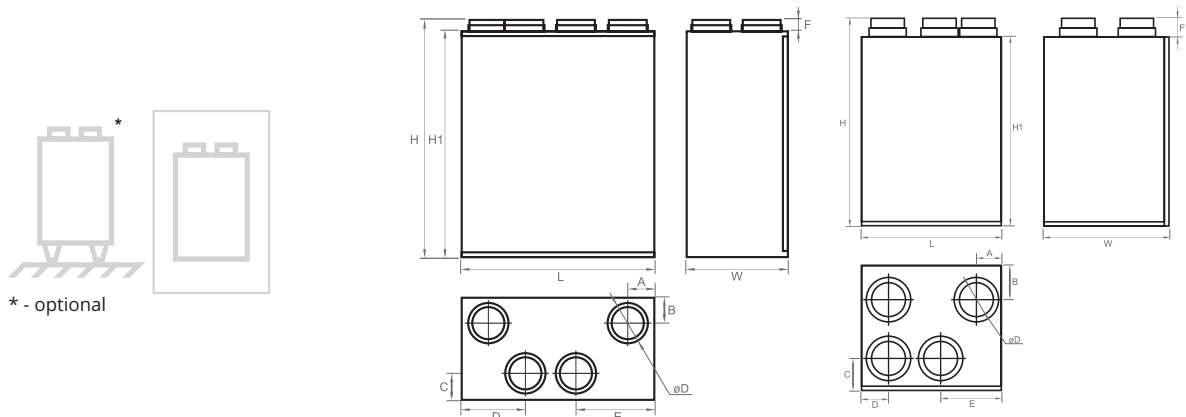





















Unit	Dimensions [mm]										
	L	W	H	H1	F	A	B	C	D	E	øD
Smarty 2X V	595	316	732	697	35	82	79	82	195	242	125/100
Smarty 3X V	599	538	900	810	80	100	145	138	112	265	150/160
Smarty 4X V	599	538	900	810	80	100	145	138	112	265	150/160

SMARTY X

ACCESSORIES

Unit	Optional accessories						
	EKA/EKA NIS	WSG	ALU	NPU	AP	MUTE	SKG
Smarty 2X P	125	-	125	125	125	125	125
Smarty 3X P	160	160	160	160	160	160	160
Smarty 4X P	160	160	160	160	160	-	160
Smarty 2X V	125	-	125	125	125	125	125
Smarty 3X V	160	160	160	160	160	160	160
Smarty 4X V	160	160	160	160	160	160	160

Network Module  MB-Gateway	Control panel  FLEX MCB	Control panel  STOUCH	Control panel  SA-Control	Electrical preheater  EKA NIS	Electrical heater  EKA	CO₂ sensors  S-RCO2-F2 S-KCO2	Humidity transmitter  S-RFF-U-D-F2 S-KFF-U
Pressure transmitter  S-1141	Nano Router  TL-WR802N	Presence detectors  IR24-P IR24-PC PATROL 701	Supply and exhaust air grilles  WSG	Couplings with sealing rubber  NPU	Smarty legs 	Outdoor ventilation grilles  ALU	Panel filters  MPL Coarse 65% (G4)
Panel filters  MPL ePM1 70% (F7)	Actuators for dampers  CM230-F-L	Shut-off damper  SKG-A	Mounting clamp  AP	Silencer  MUTE	Condensate pump  MAXI BLUE SET		

VERSIONS

Product name	Smarty 2X V 1.1	Smarty 2X V 1.2	Smarty 3X V 1.1	Smarty 3X V 1.2	Smarty 4X V 1.1	Smarty 4X V 1.2	Smarty 2X P 1.1	Smarty 2X P 1.2	Smarty 3X P 1.1	Smarty 3X P 1.2	Smarty 4X P 1.1	Smarty 4X P 1.2
Energy efficiency class	A**	A	A**	A	A*	B	A**	A	A**	A	A*	B
Control board	Mini MCB	Mini MCB Basic	Mini MCB	Mini MCB Basic	Mini MCB	Mini MCB Basic	Mini MCB	Mini MCB Basic	Mini MCB	Mini MCB Basic	Mini MCB	Mini MCB Basic
Version	Premium	Advanced	Premium	Advanced	Premium	Advanced	Premium	Advanced	Premium	Advanced	Premium	Advanced
Heat recovery	✓	✓	✓	✓	✓	✓	✓	✓	✓	✓	✓	✓
Temp.control	✓	✓	✓	✓	✓	✓	✓	✓	✓	✓	✓	✓
Bypass damper	✓	✓	✓	✓	✓	✓	✓	✓	✓	✓	✓	✓
Pressure sensor (constant air flow)			✓		✓				✓		✓	
Integrated pre-heater	✓		✓		✓							
Optional heating elements												
Duct-based pre-heater		✓**		✓**		✓**	✓	✓**	✓	✓**	✓	✓**
Duct-based heater	✓	✓**	✓	✓**	✓	✓**	✓	✓**	✓	✓**	✓	✓**

* - version V1.1 with additional CO₂ or RH sensors complies to A+/A.

** - only with pre-heater or heater.

Smarty 2X P

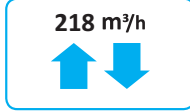

Verified:



EPDB



PCDB



Ekofund



CasaClima



	Version 1.1	Version 1.2
Ordering code	GAGSMARTY 1053_1053	GAGSMARTY 1053_1054
Electrical data		
Fans	[50Hz/VAC]	-1, 230
exhaust	[kW/A]	0.051/0.4
supply	[kW/A]	0.051/0.4
Electrical preheater integrated	[kW/A]	Optional on duct
Electrical heater	[kW/A]	Optional on duct
Max. power consumption	[kW/A]	0.10/0.85
Power connection	[50Hz/VAC]	-1, 230
Control board	MiniMCB	MiniMCB basic
Ecodesign data		
Energy efficiency class	Time control	A
	Local demand control	A
Thermal efficiency of heat recovery	[%]	86,3
Sound power level (Lwa)	[dB(A)]	49
SPI	[W/(m³/h)]	0.33
Maximum internal/external leakage rates	[%]	1.2/1.2
ErP compliance		2018
Other data		
Filters	Supply/Extract	Coarse 65%/Coarse 65% (G4/G4)*
Housing insulation, polyurethane	[mm]	20
Colour	white	RAL 9016
Weight (net, without packing)	[kg]	30
Housing protection class		IP 34
Operation		Indoors only (heated premises)

* - ePM1 70% (F7) filter is available as an option

Without frost protection	With smart frost protection	With optional preheater on duct	Extract air
0°C/+40°C/ 90%	-15°C/+40°C/ 90%	-40°C/+40°C/90%	+15°C/+40°C/60%

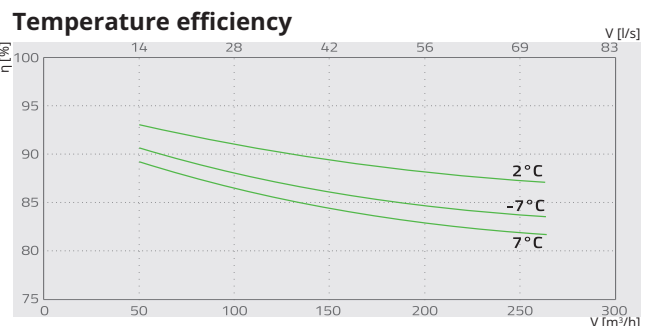
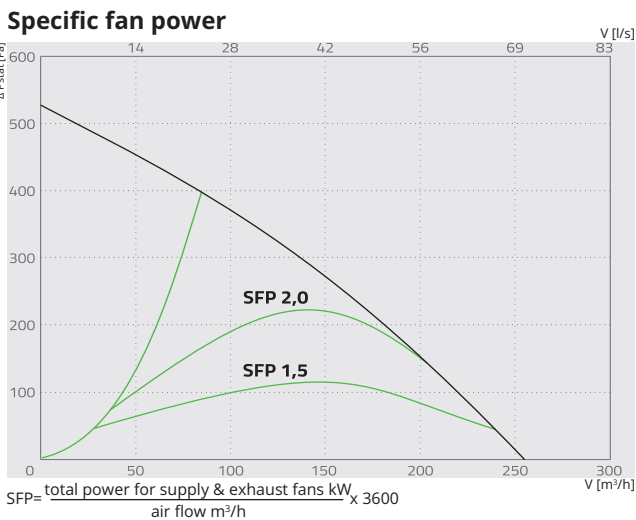
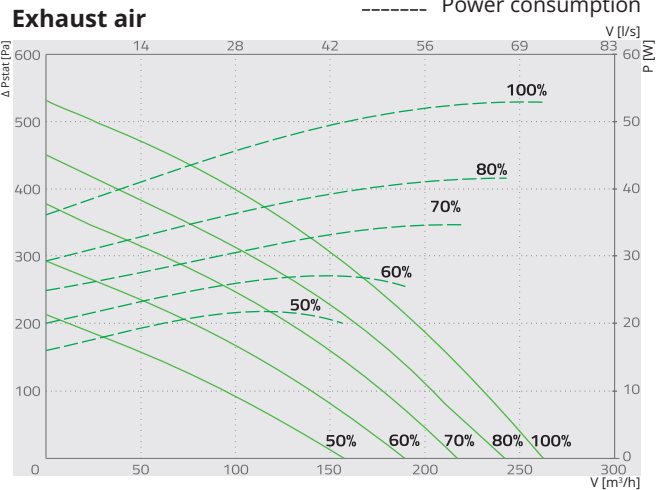
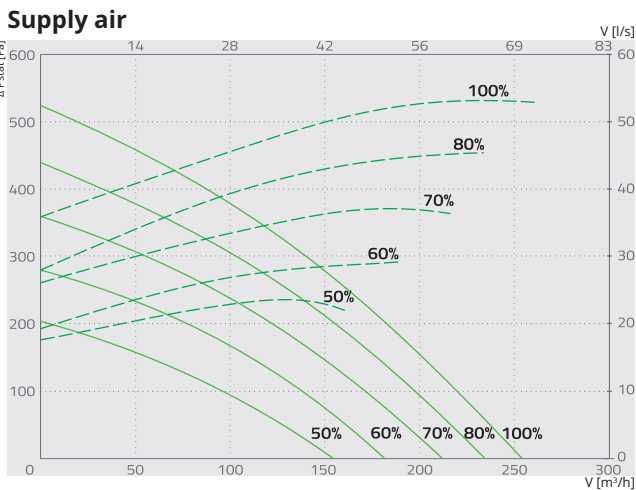

Temperature efficiency (balanced mass flow):
+7 - 20°C/39% dry / +2 - 20°C/60% wet / -7 - 20°C/39% wet

Smarty 2X P	L _{wa} total, dB(A)	L _w dB(A)							
		63 Hz	125 Hz	250 Hz	500 Hz	1000 Hz	2000 Hz	4000 Hz	8000 Hz
Outdoor	55	14	46	53	49	40	25	15	7
Supply	68	21	51	61	66	60	54	47	32
Extract	55	20	46	52	49	39	32	16	7
Exhaust	65	19	50	59	61	57	51	43	29
Surround	48	9	32	41	46	38	35	34	32

Measured at 151 m³/h, 50 Pa

SMARTY X

Smarty 3X P



45
dB

395 m³/h



Verified:



EPDB



PCDB



Ekofund



CasaClima

	Version 1.1	Version 1.2
Ordering code	GAGSMARTY 1063_1063	GAGSMARTY 1064_1064
Electrical data		
Fans	[50Hz/VAC]	~1, 230
exhaust	[kW/A]	0.085/0.75
supply	[kW/A]	0.085/0.75
Electrical preheater integrated	[kW/A]	Optional on duct
Electrical heater	[kW/A]	Optional on duct
Max.power consumption	[kW/A]	0.17 /1.55
Power connection	[50Hz/VAC]	~1, 230
Control board	MiniMCB	MiniMCB basic
Ecodesign data		
Energy efficiency class	Time control Local demand control	A
Thermal efficiency of heat recovery	[%]	85
Sound power level (Lwa)	[dB(A)]	45
SPI	[W/(m³/h)]	0,28
Maximum internal/external leakage rates	[%]	1.2/1.2
ErP compliance		2018
Other data		
Filters	Supply/Extract	Coarse 65%/Coarse 65% (G4/G4)*
Housing insulation, polyurethane	[mm]	30
Colour	white	RAL 9016
Weight (net, without packing)	[kg]	53
Housing protection class		IP 34
Operation		Indoors only (heated premises)

* - ePM1 70% (F7) filter is available as an option

Without frost protection	With smart frost protection	With optional preheater on duct	Extract air
0°C/+40°C/90%	-15°C/+40°C/90%	-40°C/+40°C/90%	+15°C/+40°C/60%



View from inspection side

Exhaust air Extract air outdoor air Supply air

— Performance
- - - - Power consumption

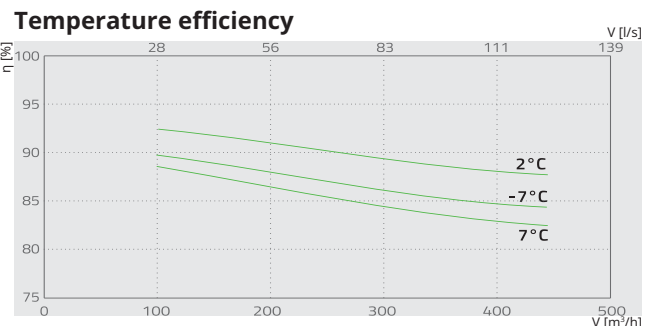
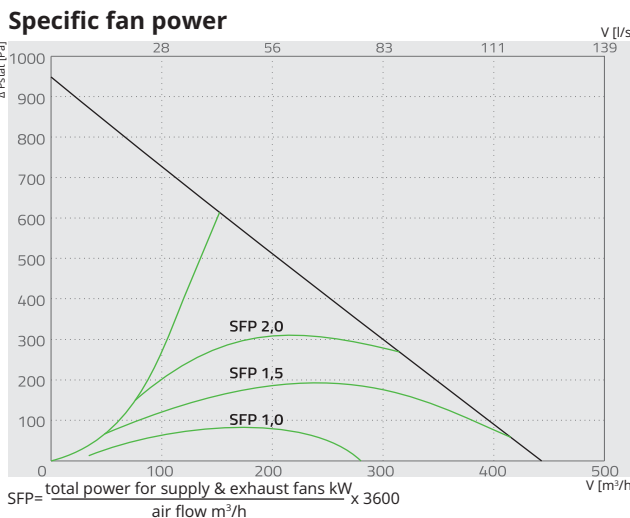
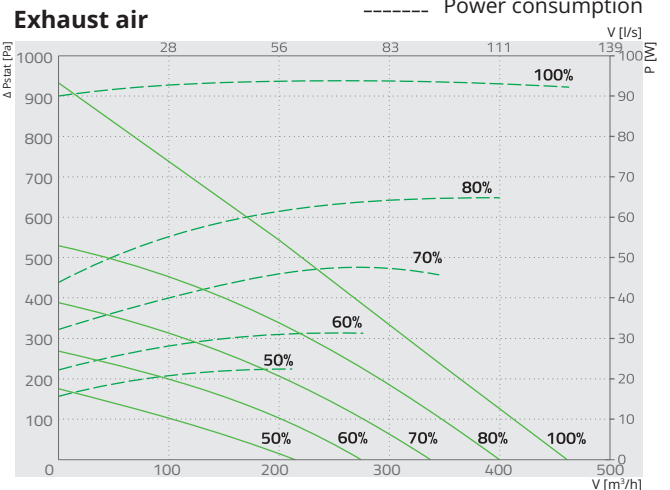
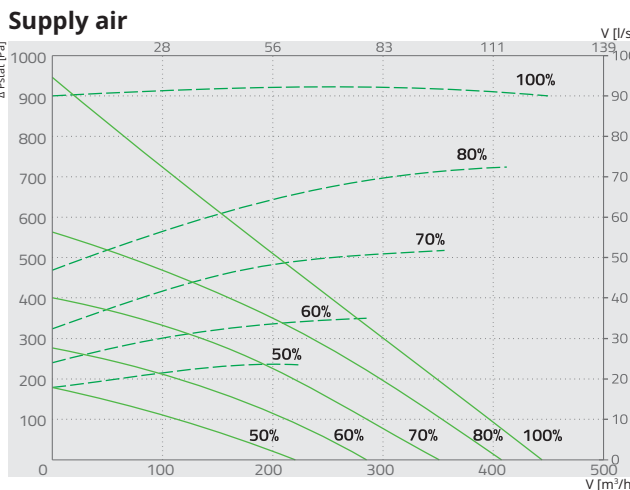

Temperature efficiency (balanced mass flow):
+7 - 20°C/39% dry / +2 - 20°C/60% wet / -7 - 20°C/39% wet

Smarty 3X P	L _{wa} total, dB(A)		L _{wM} dB(A)						
	63 Hz	125 Hz	250 Hz	500 Hz	1000 Hz	2000 Hz	4000 Hz	8000 Hz	
Outdoor	63	22	54	62	53	38	31	20	12
Supply	68	26	58	66	62	56	53	47	35
Extract	62	22	54	61	52	39	32	21	11
Exhaust	66	22	54	62	62	57	53	47	35
Surround	45	15	33	42	39	33	32	33	34

Measured at 277 m³/h, 50 Pa

Smarty 4X P

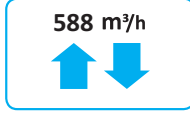

	Version 1.1	Version 1.2
Ordering code	GAGSMARTY 1096_1096	GAGSMARTY 1099_1099
Electrical data		
Fans	[50Hz/VAC]	-1, 230
exhaust	[kW/A]	0.21 / 0.92
supply	[kW/A]	0.21 / 0.92
Electrical preheater integrated	[kW/A]	Optional on duct
Electrical heater	[kW/A]	Optional on duct
Max. power consumption	[kW/A]	0.42/1.89
Power connection	[50Hz/VAC]	-1, 230
Control board	MiniMCB	MiniMCB basic
Ecodesign data		
Energy efficiency class	Time control	B
	Local demand control	A
Thermal efficiency of heat recovery	[%]	82
Sound power level (Lwa)	[dB(A)]	54
SPI	[W/(m³/h)]	0.42
Maximum internal/external leakage rates	[%]	1.2/1.2
ErP compliance		2018
Other data		
Filters	Supply/Extract	Coarse 65%/Coarse 65% (G4/G4)*
Housing insulation, polyurethane	[mm]	30
Colour	white	RAL 9016
Weight (net, without packing)	[kg]	53
Housing protection class		IP 34
Operation		Indoors only (heated premises)

* - ePM1 70% (F7) filter is available as an option

Without frost protection	With smart frost protection	With optional preheater on duct	Extract air
0°C/+40°C/ 90%	-15°C/+40°C/ 90%	-40°C/+40°C/90%	+15°C/+40°C/60%



Verified:

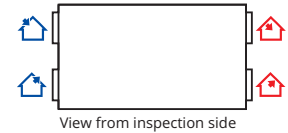

🏠 Exhaust air
 🏠 Extract air
 🏠 outdoor air
 🏠 Supply air

— Performance
 - - - Power consumption

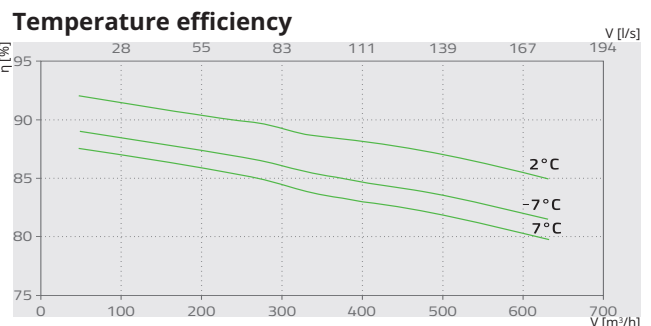
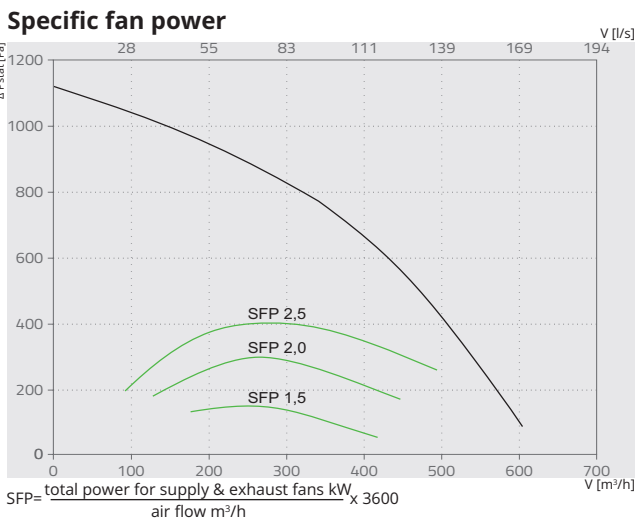
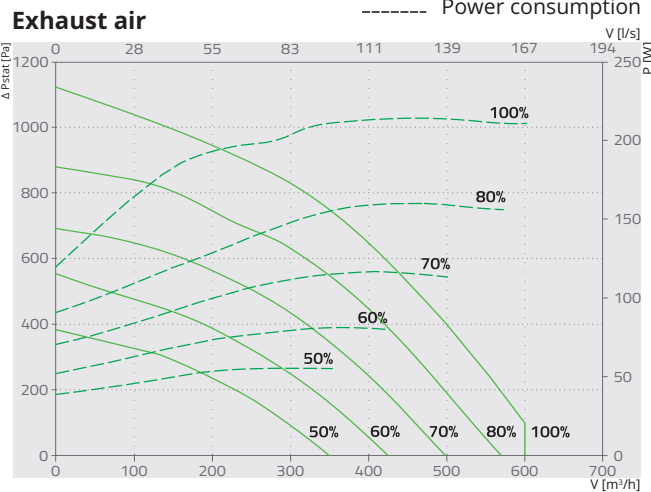
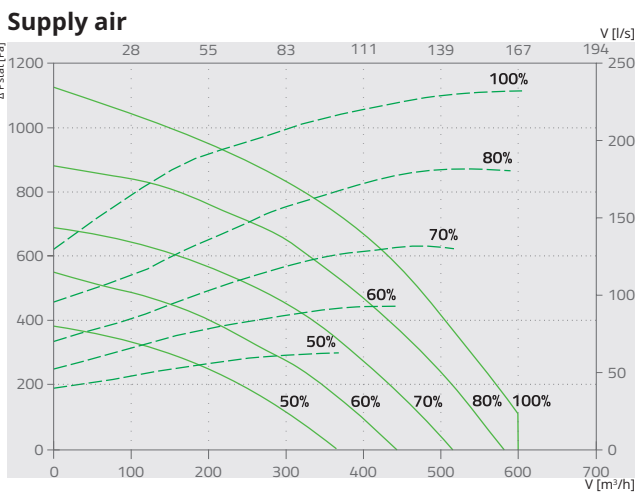

Temperature efficiency (balanced mass flow):
 +7 - 20°C/39% dry / +2 - 20°C/60% wet / -7 - 20°C/39% wet

Smarty 4X P	L _{wa} total, dB(A)	L _w dB(A)							
		63 Hz	125 Hz	250 Hz	500 Hz	1 kHz	2 kHz	4 kHz	8 kHz
Supply	60	45	49	55	54	53	49	43	37
Extract	53	43	44	50	45	43	41	35	31
Surrounding	52	32	36	49	47	43	38	30	27

Measured at 416 m³/h, 50 Pa

SMARTY X

Smarty 2X V

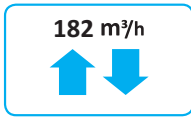

Verified:



EPDB



PCDB



Ekofund



CasaClima

	Version 1.1	Version 1.2
Ordering code	GAGSMARTY 1933_1035	GAGSMARTY 1933_1036

Electrical data		
Fans	[50Hz/VAC]	~1, 230
exhaust	[kW/A]	0.035/0.35
supply	[kW/A]	0.035/0.35
Electrical preheater integrated	[kW/A]	0.6 Optional on duct
Electrical heater	[kW/A]	Optional on duct
Max.power consumption	[kW/A]	0.67/3.35 0.07/0.75
Power connection	[50Hz/VAC]	~1, 230
Control board	MiniMCB	MiniMCB basic

Ecodesign data		
Energy efficiency class	Time control	A A
	Local demand control	A+ A
Thermal efficiency of heat recovery	[%]	90,4
Sound power level (Lwa)	[dB(A)]	51
SPI	[W/(m³/h)]	0.31
Maximum internal/external leakage rates	[%]	1.2/1.2
ErP compliance		2018

Other data		
Filters	Supply/Extract	Coarse 65%/Coarse 65% (G4/G4)*
Housing insulation, polyurethane	[mm]	30
Colour	white	RAL 9016
Weight (net, without packing)	[kg]	25
Housing protection class		IP 34
Operation		Indoors only (heated premises)

* - ePM1 70% (F7) filter is available as an option

Without frost protection	With smart frost protection	With integrated preheater	With optional preheater on duct	Extract air
0°C/+40°C/ 90%	-15°C/+40°C/ 90%	-15°C/+40°C/ 90%	-40°C/+40°C/90%	+15°C/+40°C/60%

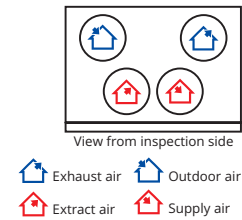
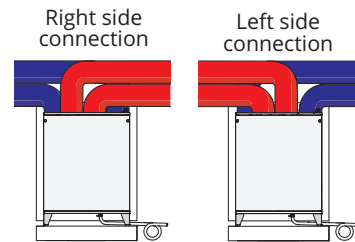

Supply air

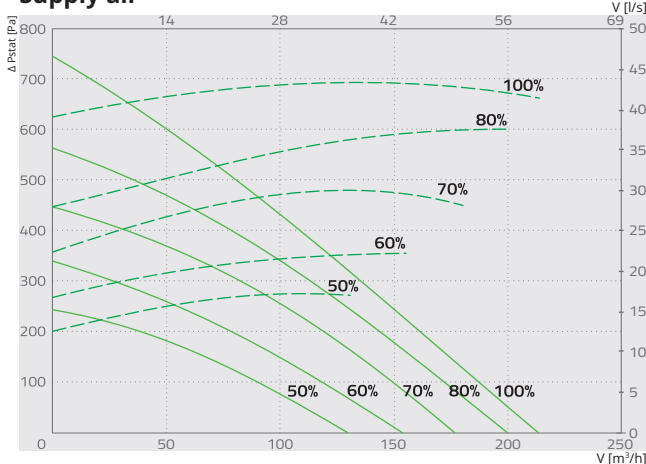

Exhaust air

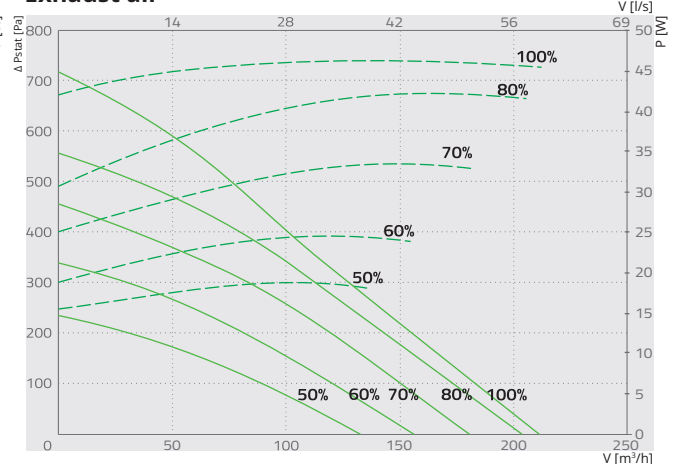

Specific fan power

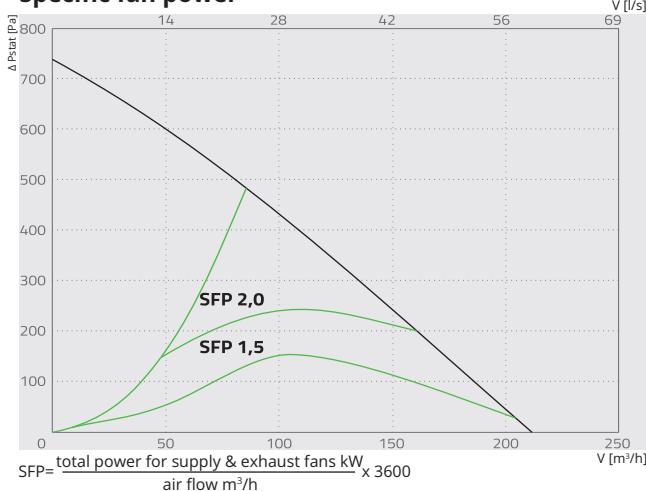

Temperature efficiency

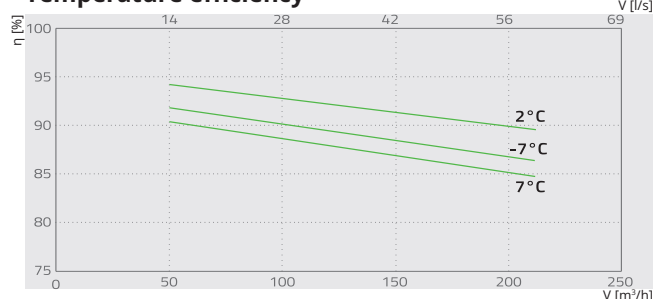

Temperature efficiency (balanced mass flow):
+7 - 20°C/39% dry / +2 - 20°C/60% wet / -7 - 20°C/39% wet

Smarty 2X V	L _{wa} total, dB(A)	L _{wa} dB(A)							
		63 Hz	125 Hz	250 Hz	500 Hz	1000 Hz	2000 Hz	4000 Hz	8000 Hz
Outdoor	53	12	44	51	45	40	26	14	4
Supply	63	17	48	57	60	56	51	48	33
Extract	55	12	44	51	52	43	26	19	6
Exhaust	68	21	52	60	64	62	54	51	36
Surround	51	8	32	42	47	43	43	42	38

Measured at 126 m³/h, 50 Pa

Smarty 3X V

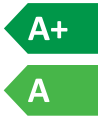

	Version 1.1	Version 1.2
Ordering code	GAGSMARTY 1923_1044	GAGSMARTY 1057_1057
Electrical data		
Fans	[50Hz/VAC]	-1, 230
exhaust	[kW/A]	0.083/ 0.75
supply	[kW/A]	0.083/ 0.75
Electrical preheater integrated	[kW/A]	1.2 Optional on duct
Electrical heater	[kW/A]	Optional on duct
Max.power consumption	[kW/A]	1.37/ 6.75 0.17/1.55
Power connection	[50Hz/VAC]	-1, 230
Control board	MiniMCB	MiniMCB basic
Ecodesign data		
Energy efficiency class	Time control	A
	Local demand control	A+
Thermal efficiency of heat recovery	[%]	86,9
Sound power level (Lwa)	[dB(A)]	50
SPI	[W/(m³/h)]	0.26
Maximum internal/external leakage rates	[%]	1.2/1.2
ErP compliance		2018
Other data		
Filters	Supply/Extract	Coarse 65%/Coarse 65% (G4/G4)*
Housing insulation, polyurethane	[mm]	30
Colour	white	RAL 9016
Weight (net, without packing)	[kg]	39
Housing protection class		IP 34
Operation		Indoors only (heated premises)

* - ePM1 70% (F7) filter is available as an option

Without frost protection	With smart frost protection	With integrated preheater	With optional preheater on duct	Extract air
0°C/+40°C/ 90%	-15°C/+40°C/ 90%	-15°C/+40°C/ 90%	-40°C/+40°C/90%	+15°C/+40°C/60%



Verified:



EPDB



PCDB



Ekofund



CasaClima

Smarty 3X V

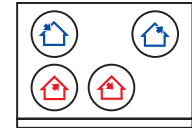

View from inspection side

🏠 Exhaust air
 🏠 Extract air
 🏠 outdoor air
 🏠 Supply air

Supply air

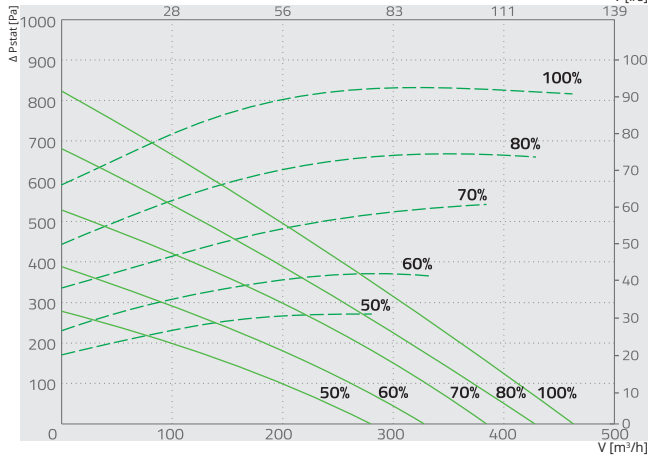

Exhaust air

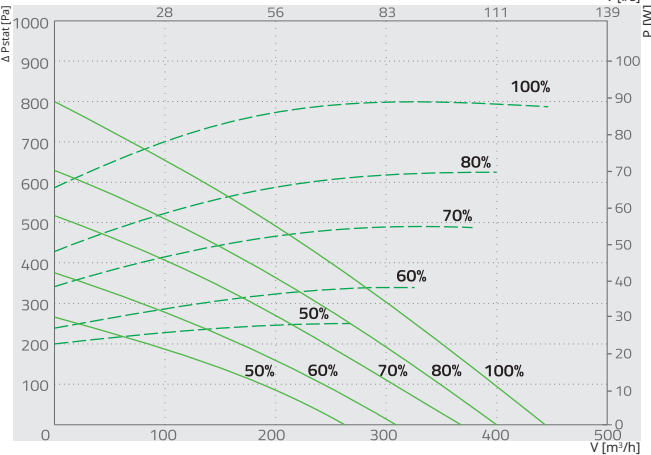

Specific fan power

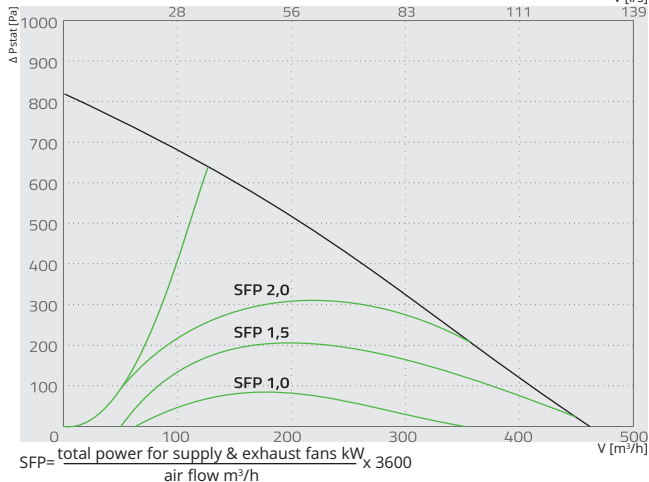

Temperature efficiency

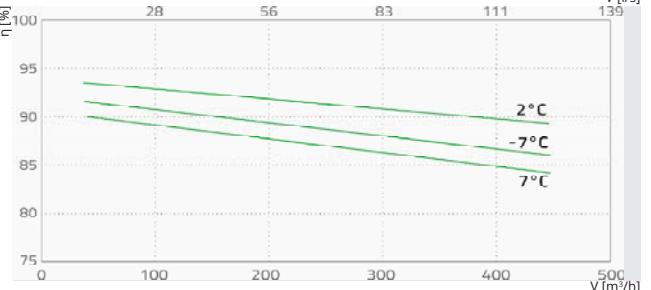

Temperature efficiency (balanced mass flow):
 +7 - 20°C/39% dry / +2 - 20°C/60% wet / -7 - 20°C/39% wet

Smarty 3X V	L _{wa} total, dB(A)	L _{wM} dB(A)							
		63 Hz	125 Hz	250 Hz	500 Hz	1000 Hz	2000 Hz	4000 Hz	8000 Hz
Outdoor	56	16	48	55	47	37	30	21	14
Supply	66	22	53	62	62	57	52	41	31
Extract	60	19	51	59	50	40	33	23	16
Exhaust	69	25	57	65	64	57	55	48	39
Surround	50	16	38	46	45	41	37	34	30

Measured at 277 m³/h, 50 Pa

SMARTY X

Smarty 4X V

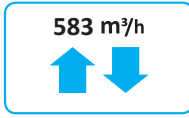

		Version 1.1	Version 1.2
Ordering code		GAGSMARTY 1056_1056	GAGSMARTY 1057_1057
Electrical data			
Fans	[50Hz/VAC]	~1, 230	
exhaust	[kW/A]	0.21/ 0.92	
supply	[kW/A]	0.21/ 0.92	
Electrical preheater integrated	[kW/A]	1.2/5.2	Optional on duct
Electrical heater	[kW/A]	Optional on duct	
Max.power consumption	[kW/A]	1.62 /7.09	0.42 /1.89
Power connection	[50Hz/VAC]	~1, 230	
Control board		MiniMCB	MiniMCB basic
Ecodesign data			
Energy efficiency class	Time control	B	B
	Local demand control	A	A
Thermal efficiency of heat recovery	[%]	82	
Sound power level (Lwa)	[dB(A)]	54	
SPI	[W/(m³/h)]	0.4	
Maximum internal/external leakage rates	[%]	1.2/1.2	
ErP compliance		2018	
Other data			
Filters	Supply/Extract	Coarse 65%/Coarse 65% (G4/G4)*	
Housing insulation, polyurethane	[mm]	30	
Colour		white RAL 9016	
Weight (net, without packing)	[kg]	39	
Housing protection class		IP 34	
Operation		Indoors only (heated premises)	

* - ePM1 70% (F7) filter is available as an option

Without frost protection	With smart frost protection	With integrated preheater	With optional preheater on duct	Extract air
0°C/+40°C/ 90%	-15°C/+40°C/ 90%	-10°C/+40°C/ 90%	-40°C/+40°C/90%	+15°C/+40°C/60%

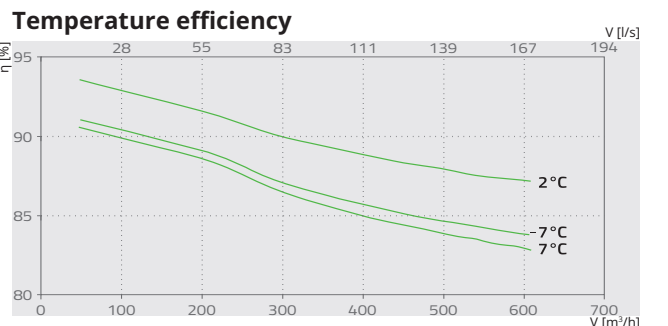
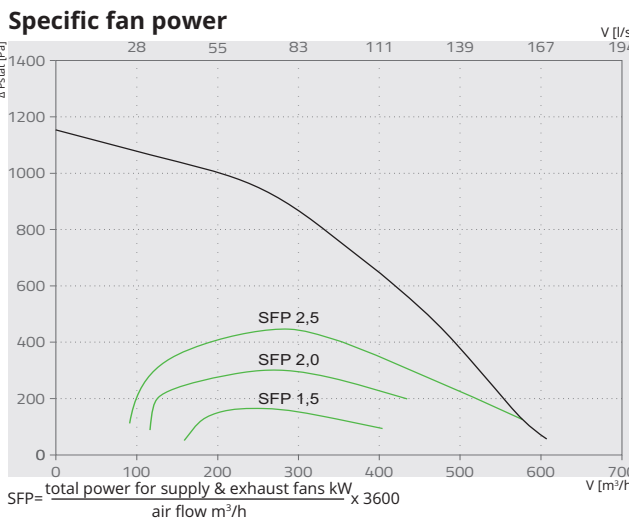
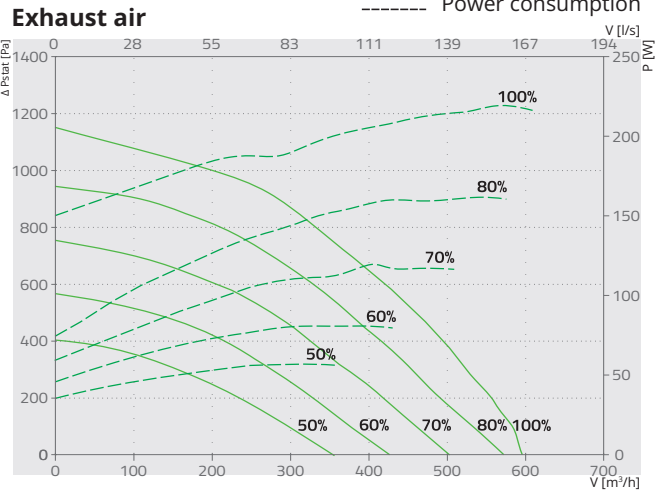
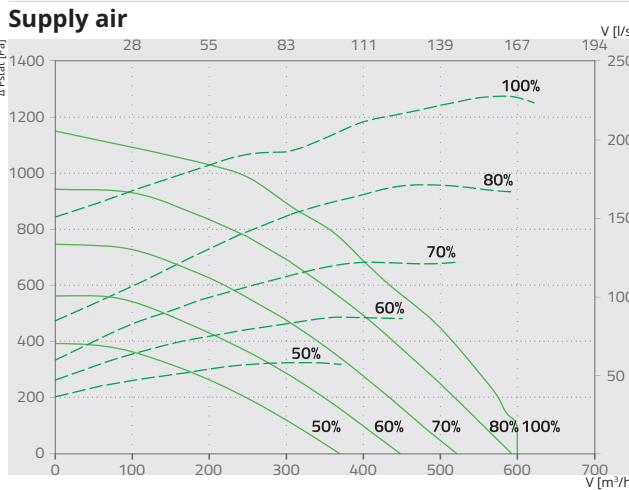
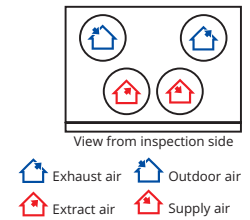
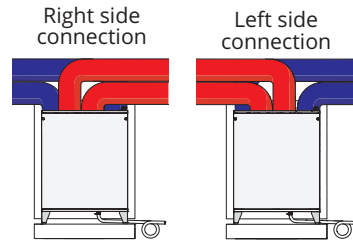

Temperature efficiency (balanced mass flow):
+7 - 20°C/39% dry / +2 - 20°C/60% wet / -7 - 20°C/39% wet

Smarty 4X V	L _{wa} total, dB(A)	L _{WA} dB(A)							
		63 Hz	125 Hz	250 Hz	500 Hz	1 kHz	2 kHz	4 kHz	8 kHz
Supply	62	47	53	58	56	54	51	46	41
Extract	54	44	45	50	47	45	43	38	35
Surrounding	51	30	35	48	46	40	35	27	24

Measured at 406 m³/h, 50 Pa

Smarty 2X P* / 3X P / 4X P versions v1.1 with electrical heater **

*- 2X P is without constant air flow and constant pressure functions

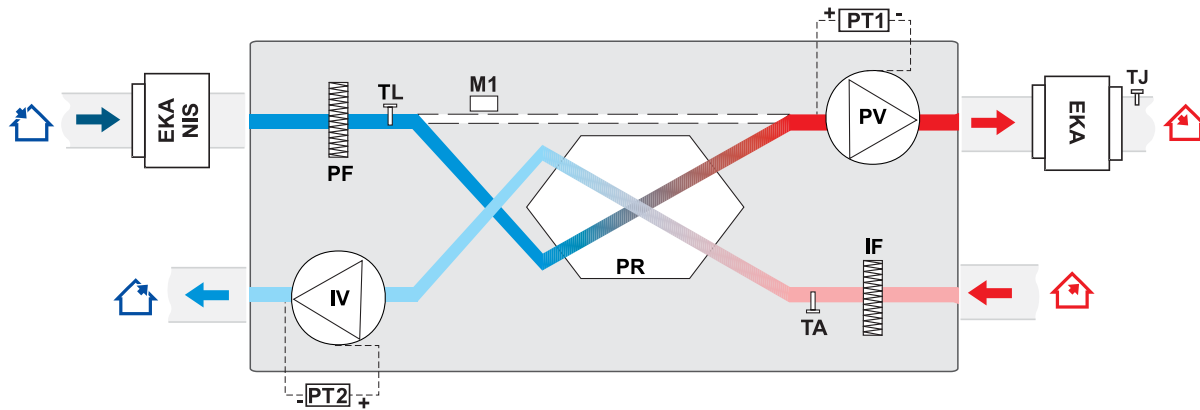

** - Smarty 2X P / 3X P / 4X P versions v1.2 with electrical heater

- | | |
|--|---|
| IV - exhaust air fan | TL - fresh air temperature sensor |
| PV - supply air fan | TJ - supply air temperature sensor |
| PR - plate heat exchanger | EKA NIS - electric pre-heater (only electric pre-heater or heater) |
| PF - filter for supply air | EKA - electric heater (only electric pre-heater or heater) |
| IF - filter for extract air | PT1 - supply air fan pressure transmitter |
| M1 - actuator of by-pass damper | PT2 - exhaust air fan pressure transmitter |
| TA - extract air temperature sensor | |

Smarty 2X V* / 3X V / 4X V versions v1.1 with electrical heater

* - 2X V is without constant air flow and constant pressure functions

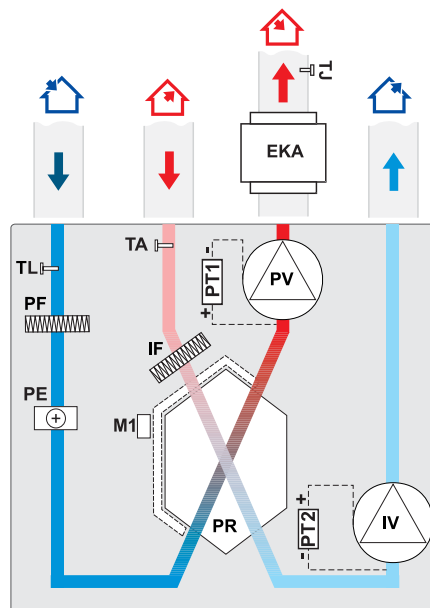

- | | |
|--|---|
| IV - exhaust air fan | TL - fresh air temperature sensor |
| PV - supply air fan | TJ - supply air temperature sensor |
| PR - plate heat exchanger | EKA - electric heater (only electric pre-heater or heater) |
| PF - filter for supply air | PE - electric pre-heater |
| IF - filter for extract air | PT1 - supply air fan pressure transmitter |
| M1 - actuator of by-pass damper | PT2 - exhaust air fan pressure transmitter |
| TA - extract air temperature sensor | |

SMARTY X

Smarty 2X V / 3X V / 4X V versions v1.2 with electrical heater

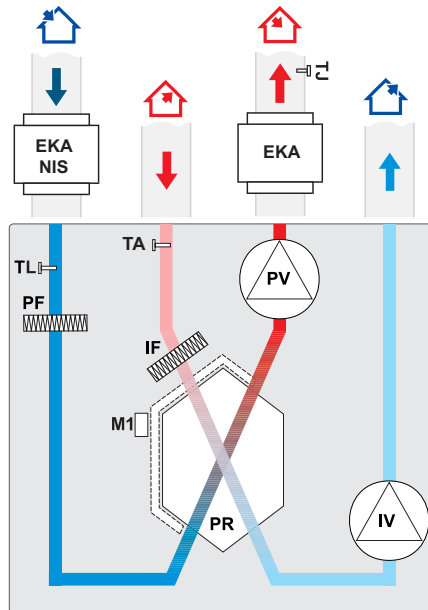

- IV** - exhaust air fan
- PV** - supply air fan
- PR** - plate heat exchanger
- PF** - filter for supply air
- IF** - filter for extract air
- M1** - actuator of by-pass damper

- TA** - extract air temperature sensor
- TL** - fresh air temperature sensor
- TJ** - supply air temperature sensor
- EKA** - electric heater (only electric pre-heater or heater)
- EKA NIS** - electric pre-heater (only electric pre-heater or heater)

FUNCTIONS			
Descriptions of the functions	Functions	MiniMCB	MiniMCB basic
		Smarty range	
	Date and time settings	+	+
	System modes for easy and-user friendly control: Stand-by, Building protection, Economy, Comfort.	+	+
	BOOST function (Fans operate at highest speed)	+	+
	Cold/heat recovery	+	+
	Fire place function	+	-
	Fireplace protection (NC)	o	-
	Fire protection	+	+
	Winter/summer mode	+	+
	System monitoring	o	o
	Alarm indication output	+	-
	Operation indication output	+	-
	Digital input configuration	+	+
	Event register (storing up to 50 entries)	+	+
	Dryness protection	o	o
	Constant air pressure	+	-
	Constant airflow mode	+	-
	Heat exchanger frost protection	+	+
	Manual components control	o	o
	Weekly schedule	+	+
	Holiday schedule	+	+
	CO ₂ level indication and reduction function	o	o ¹
	Night cooling function	+	+
	Relative humidity (RH) level indication and reduction function	o	o ¹
	Supply air temperature control according to the extract air sensor	+	+
	Reset to factory defaults	+	+
	Functional units		
Fans	Speed synchronous/asynchronous 0-10V control	+	+
	Protection by RPM	+	+
	Protection by pressure	+	-
Electric heater	On/off and 0-10V control	+	*
	Automatic and Manual protection (NC)	+	*
Electric pre-heater	On/off and 0-10V control	+	*
	Pre-heater manual/automatic protection (NC)	+	*
Air dampers	Outdoor air dampers control	+	+
Filters clogging monitoring	Air filters timer	+	+
Sensors	Supply air temperature sensor	+	+
	Outdoor air temperature sensor	+	+
	Extract air temperature sensor	+	+
Remote controllers	S-Touch	x	x
	Flex MCB	x	x
	SA Control	x	x
	MB Gateway	x	x
Building management system	Modbus	+	+
	BACnet/IP	o	o

o	Required additional components: CO2 and moisture sensors, switches, etc.
+	Standard feature (the number of features depends on the ventilation unit in which the automatics are used); to be configured through BMS network or remote control panel
x	Remote control panels
*	Only one heater or pre-heater can be connected
o ¹	Only one sensor can be connected